



**Art.-Nr: ZAW418SC-COOLIP54**  
**Safety luminaire Single Battery**  
**Wall mounting, SelfControl (SC), 3 h, , IP65, Zinc die-cast,**  
**white**

Robust, zinc die-cast wall surface-mounted luminaire for illuminating escape and emergency routes.

Particularly suited to illuminating escape and emergency routes at the exit and outside the building up to a safe zone. The radiating characteristics distribute the light parallel to the wall.

Automatic monitoring of safety luminaire with SelfControl.



More information

[www.rp-group.com/en/item/ZAW418SC-COOLIP54](http://www.rp-group.com/en/item/ZAW418SC-COOLIP54)



## TECHNICAL DATA

Luminaire type	Safety luminaire
Mounting	Wall mounting
Pictograph	No
Illuminant	LED
Housing material	Zinc die-cast
Housing color	white
Protection type (IP)	IP65
Impact resistance (IK)	8
Certification	WEEE, CE
Insulation class	1
Supply	Single Battery
Monitoring	SelfControl (SC)
Bridging time	3 h
Battery	LiFePO4 3,2 V/3,3 Ah
Operating mode	Standby circuit / permanent circuit
Input voltage AC	230 V
Input frequency	50 / 60 Hz
Input voltage DC	- V



Power max.	5,3 W
Power DS	3,9 W
Power BS	1,5 W
Ambient temperature DS	-5 °C - 35 °C
Ambient temperature BS	-5 °C - 40 °C
Depth	315 mm
Width	65 mm
Height	140 mm
Weight	2.1
Weight incl. packaging	2.22
Connection cross-section	2.5 mm <sup>2</sup>
Switching input	Yes
Emergency light blocking	No
Battery connection	Connector
Dimming function	No
Luminous flux mains	190 lm
Luminous flux emergency	190 lm
Customs tariff number	94056180
EAN	4262483025079

## TECHNICAL DRAWING

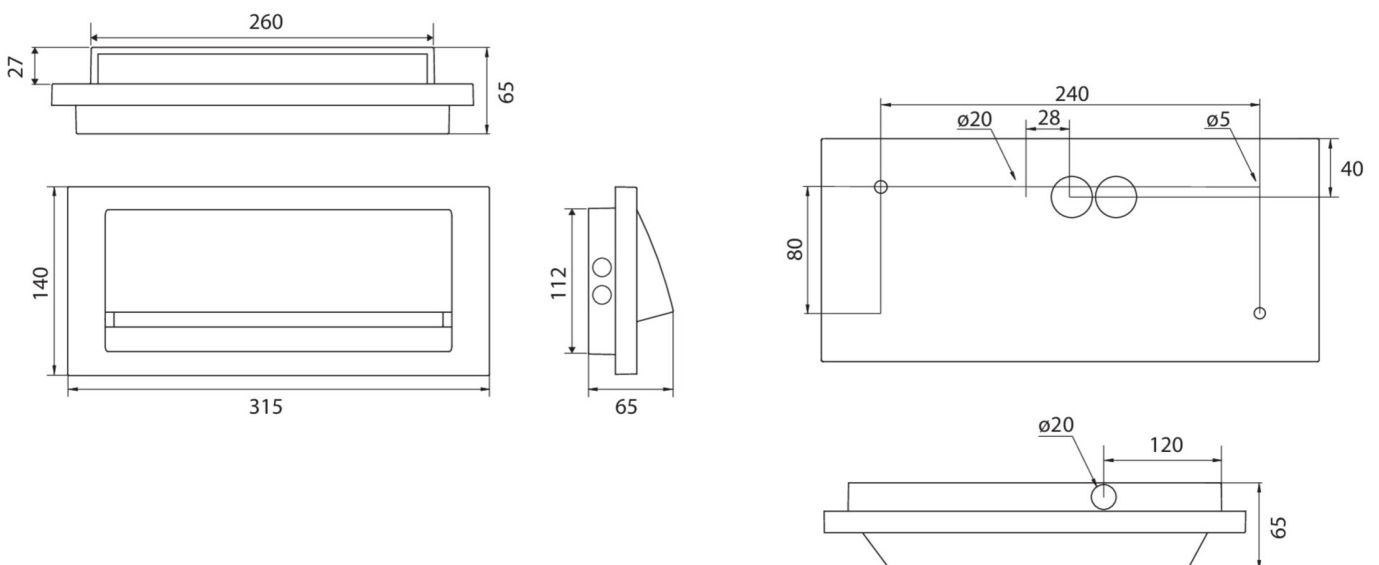

As of: 04.11.2024 - Subject to technical changes and errors.