



**Art.-Nr: QAW428WL-SI**  
**General light, Safety luminaire Single Battery**  
**Universal, Wireless Professional (WL), 8 h, , IP20, Aluminium,**  
**Anodised aluminium**

Round aluminium LED luminaire, general-purpose luminaire with integrated safety light function for illuminating escape and emergency routes.

Wireless central control and monitoring for large installations of up to 50,000 luminaires with Wireless Professional.



More information

[www.rp-group.com/en/item/QAW428WL-SI](http://www.rp-group.com/en/item/QAW428WL-SI)



## TECHNICAL DATA

Luminaire type	General light, Safety luminaire
Mounting	Universal
Pictograph	No
Illuminant	LED
Housing material	Aluminium
Housing color	Anodised aluminium
Protection type (IP)	IP20
Impact resistance (IK)	≥ 3
Certification	WEEE, CE
Insulation class	1
Supply	Single Battery
Monitoring	Wireless Professional (WL)
Bridging time	8 h
Battery	3,2V V 3,3Ah Ah/
Operating mode	Standby circuit / permanent circuit
Input voltageAC	230 V
Input frequency	50 / 60 Hz
Power max.	30 W
Power DS	26,4 W



Power BS	0,4 W
Ambient temperature DS	-5 °C - 30 °C
Ambient temperature BS	-5 °C - 35 °C
Height	113 mm
Diameter	395 mm
Weight	0.78
Weight incl. packaging	1.1
Connection cross-section	2.5 mm <sup>2</sup>
Switching input	Yes
Emergency light blocking	No
Battery connection	Connector
Dimming function	Yes
Luminous flux mains	2300 lm
Luminous flux emergency	125 lm
Customs tariff number	94056180
EAN	4260682159984



TECHNICAL DRAWING

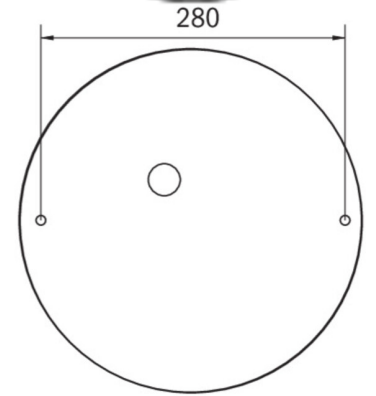
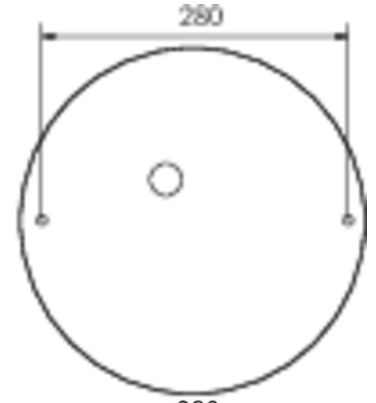

As of: 23.08.2024 - Subject to technical changes and errors.