



Art.-Nr: KWIW423WL
Safety luminaire Single Battery
Universal, Wireless Professional, 3 h, , IP65, Plastic, white

Classic bar-shaped polycarbonate luminaire for wall or ceiling mounting. Straight lines as well as the robust construction with a high ingress protection allow versatile use.

Pictograms according to DIN EN ISO 7010 and DIN ISO 3864 (left, right, above, below) are included as standard in the scope of delivery.



More information



TECHNICAL DATA

Luminaire type	Safety luminaire
Mounting	Universal
Pictograph	No
Illuminant	LED
Housing material	Plastic
Housing color	white
Protection type (IP)	IP65
Impact resistance (IK)	6
Certification	CE, WEEE, D-Sign
Insulation class	2
Supply	Single Battery
Monitoring	Wireless Professional
Bridging time	3 h
Operating mode	Standby circuit / permanent circuit
Input voltageAC	230 V
Input frequency	50 Hz
Power max.	7,5 W
Power DS	5,7 W
Power BS	0,8 W
Ambient temperature DS	-5 °C - 40 °C
Ambient temperature BS	-4 °C - 40 °C
Depth	86 mm



Width	390 mm
Height	99 mm
Weight	0.86
Weight incl. packaging	0.96
Connection cross-section	2.5 mm ²
Switching input	Yes
Emergency light blocking	Yes
Battery connection	Connector
Dimming function	Yes
Luminous flux mains	250 lm
Luminous flux emergency	520 lm
Customs tariff number	94056120
EAN	4260766550454



TECHNICAL DRAWING

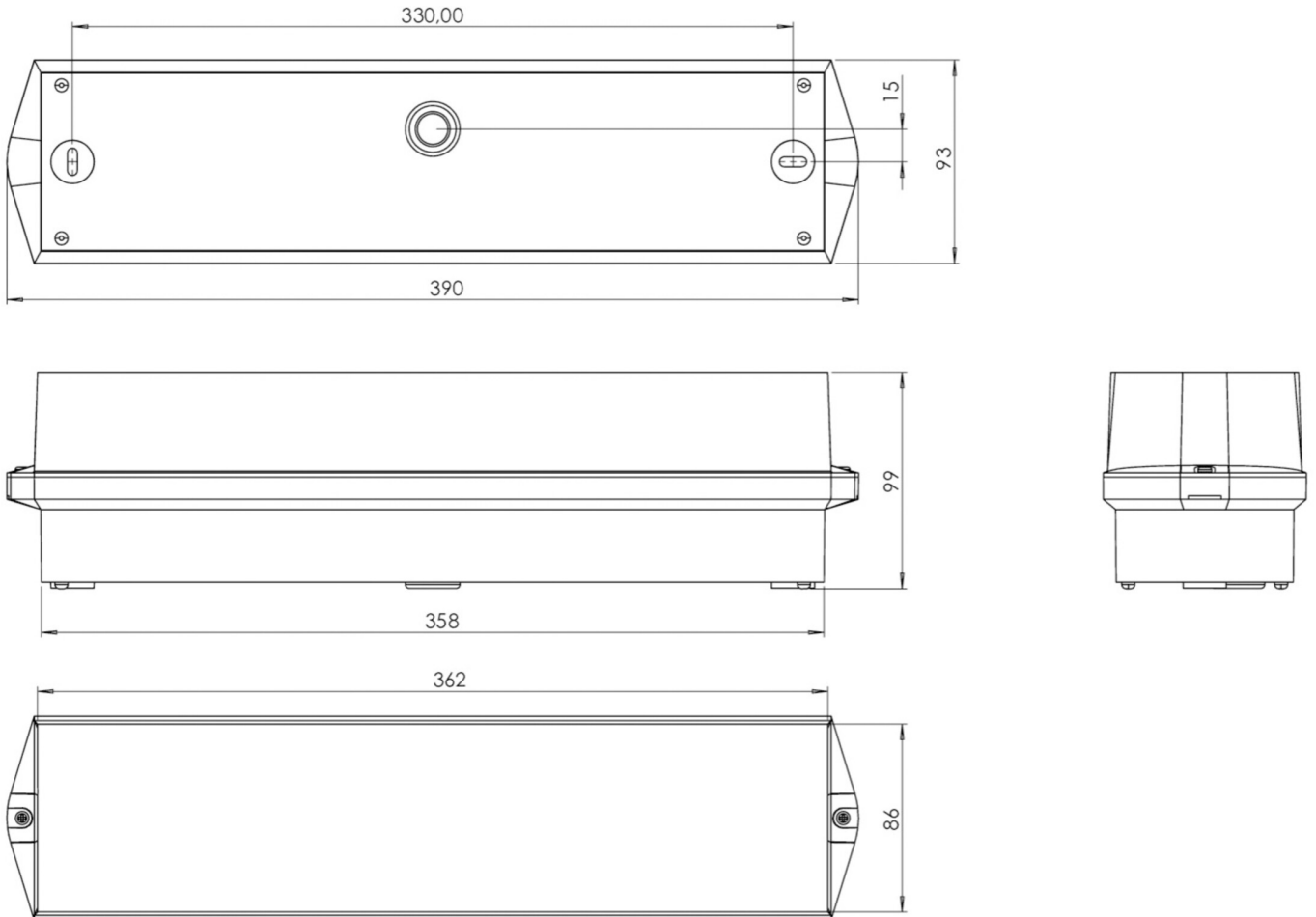

ACCESSORY LIST

- BKW -
- KWIE -
- LSYS-B4 -
- LSYS-F4 -
- LSYS-H4 -
- LSYS-R4 -
- LSYS-S4 -
- LSYS-WF4 -
- LFP3233-SET-2AKKU - LiFePO4 Battery



RELATED PRODUCTS

Art.-No.	Image	Monitoring	Supply	Color	Investment	Automatic log	Maintenance level	Remote maintenance	max. luminaires	Single luminaire monitoring
KWIW023SC		SelfControl	Single battery		€	no	high	no	unlimited	itself

As of: 16.07.2024 - Subject to technical changes and errors.