



Emergency luminaire Art.-No.: KWIW029ML

Classic bar-shaped polycarbonate luminaire for wall or ceiling mounting. Straight lines as well as the robust construction with a high ingress protection allow versatile use.



TECHNICAL DATA

Luminaire type	Emergency luminaire
Mounting	Universal
Pictograph	No
Illuminant	LED
Housing material	Polycarbonate
Colour	RAL 9003
Mechanical rating IP	65
Impact resistance IK	6
Protection class	2
Supply	Central power supply system
Monitoring	ML - Central power supply system
Operation time	CPS
Operation mode	single luminaire switching
Input Voltage AC	230 V
Input Frequency Hz	50 / 60 Hz
Input Voltage DC	216 V
Power consumption max.	5,2 W
Power consumption maintained	5,2 W
Power consumption non-maintained	1,1 W
Ambient temperature maintained mode	-30 °C / 40 °C
Ambient temperature non-maintained mode	-20 °C / 40 °C
Length	86 mm
Width	390 mm
Height	99 mm
Weight	0.7 kg
Weight incl. Packaging	0.8 kg



Connection cross-section	2.5 mm
Switching input L'	Yes
Emergency light blocking	No
Battery connector	None
Dimming function	Yes
Luminous flux mains mode	520 lm
Luminous flux emergency mode	520 lm
Customs tariff number	94056120
Coutry of origin	Germany
EAN	4260659566425

TECHNICAL DRAWING

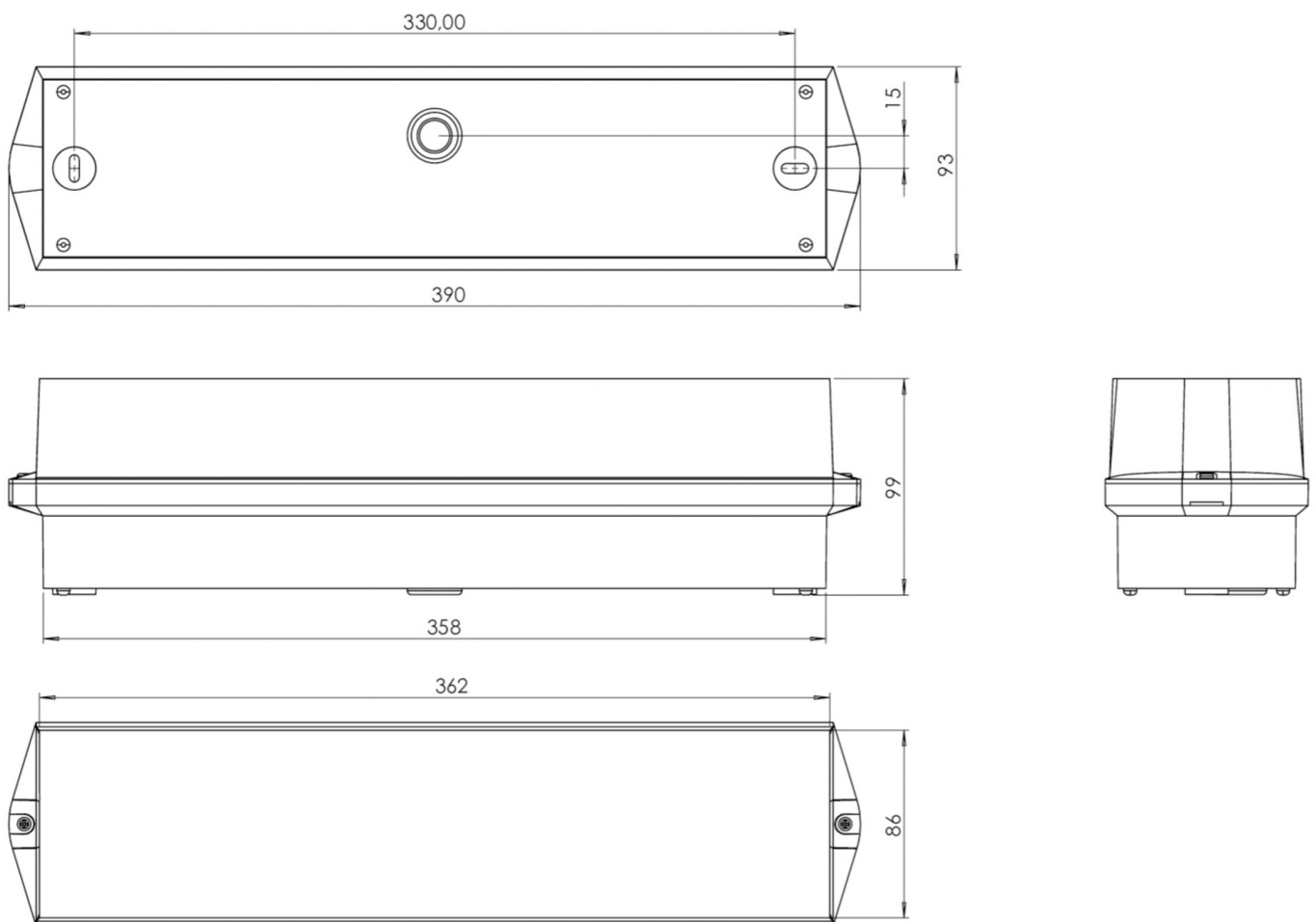



ACCESSORIES

BKW - Ball protection (KW) 420x170x170mm