



**Art.-Nr: KWID423SC-TT**  
**Exit sign Supply**  
**Ceiling, SelfControl (SC), 3 h, 16 m, IP65, Plastic, white**

Classic, robust, plastic, beam-like emergency exit sign luminaire with a high level of protection and self-adhesive pictogram for versatile use.

Intended for ceiling mounting when used as an emergency exit sign luminaire. Without the use of pictograms, it can be used as a safety luminaire, preferably for ceiling mounting.

Automatic monitoring of safety luminaire with SelfControl. The innovative integrated lens holder with a rapid fitting fixture permits the flexible use of various lens types. Using the right lens allows the distribution of light to be matched perfectly to the application and simplifies illumination which satisfies all relevant standards. A round lens and hall lens are supplied with every luminaire, allowing it to be adapted perfectly to the respective mounting situation. Other lenses, such as a spotlight lens, beam lens or H lens, are available as options.



More information

[www.rp-group.com/en/item/KWID423SC-TT](http://www.rp-group.com/en/item/KWID423SC-TT)



## TECHNICAL DATA

Luminaire type	Exit sign
Mounting	Ceiling
Recognition distance	16 m
Pictograph	Set
Housing material	Plastic
Housing color	white
Protection type (IP)	IP65
Impact resistance (IK)	6
Certification	CE, WEEE, D-Sign
Insulation class	2
Monitoring	SelfControl (SC)
Bridging time	3 h
Battery	/
Power max.	6,7 W
Power DS	5,4 W
Power BS	0,9 W



Ambient temperature DS	-15 °C - 40 °C
Ambient temperature BS	-15 °C - 40 °C
Depth	93 mm
Width	390 mm
Height	139 mm
Weight	0.77
Weight incl. packaging	0.87
Luminous flux mains	500 lm
Luminous flux emergency	500 lm
EAN	4260766558245

## TECHNICAL DRAWING

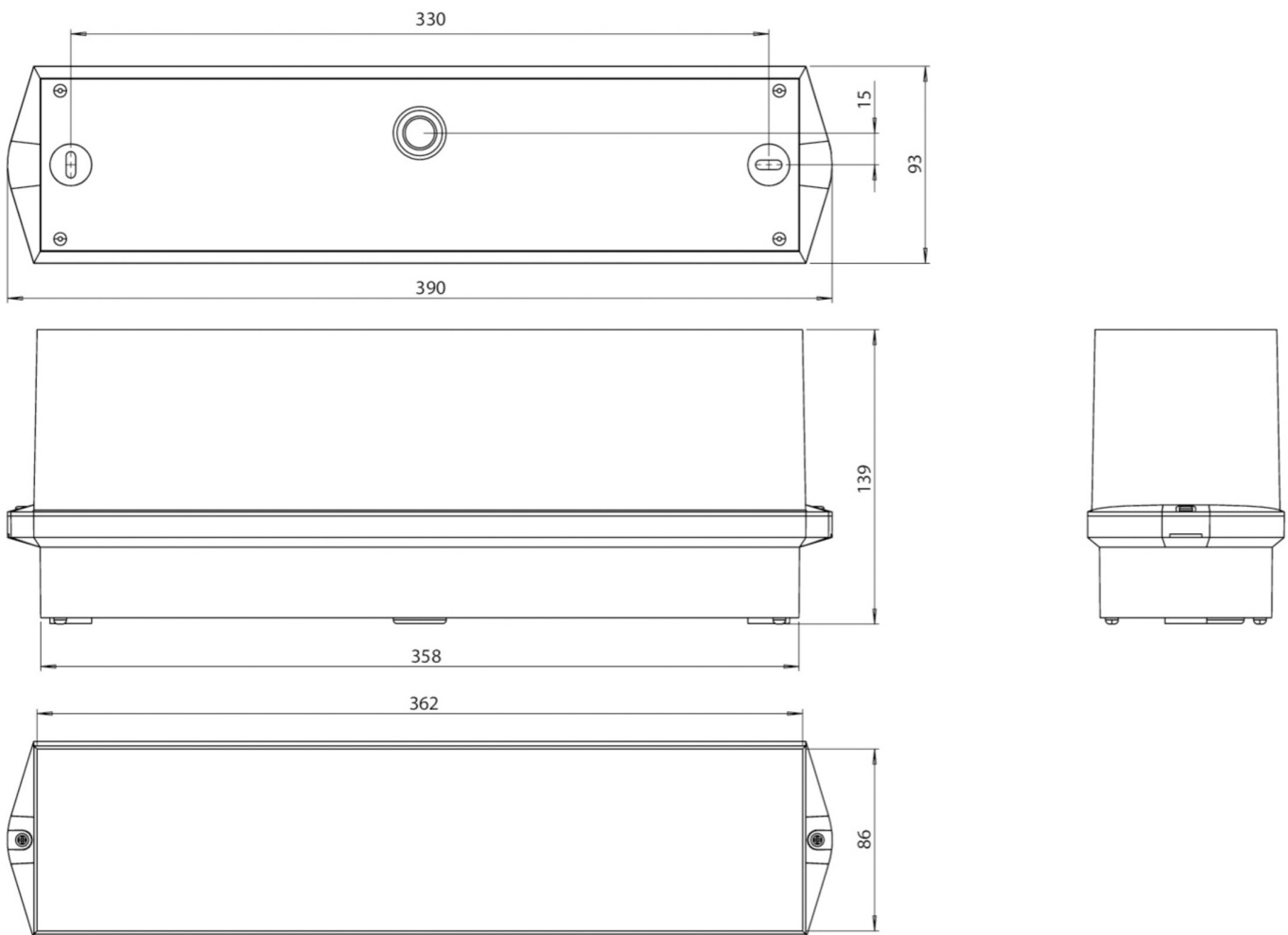



## ACCESSORY LIST

BKW -

As of: 23.08.2024 - Subject to technical changes and errors.