



Art.-Nr: GAXD403SC

Exit sign

Ceiling, SelfControl (SC), 3 h, 30 m, IP40, Plastic, white

Emergency exit sign luminaire with plastic pane for surface mounting on the ceiling and for identifying emergency and escape routes. It is based on the design of the A series luminaire family, which provides solutions for any mounting and has won the German Design Award for its uniform, straight-line design. The luminaires are equipped with modern LED illuminants and provide flexibility through their interchangeable pictograms.

Automatic monitoring of safety luminaire with SelfControl. Display edge luminaire with integrated light distribution for even pictogram illumination. Suited to inscription on one or two sides. Planning certainty is provided by tool-free, variable use of the pictograms on site. A set of pictograms corresponding to DIN ISO 7010 (arrow to the right, left, up and down) is supplied as standard.



More information

www.rp-group.com/en/item/GAXD403SC



TECHNICAL DATA

Luminaire type	Exit sign
Mounting	Ceiling
Recognition distance	30 m
Pictograph	Set
Illuminant	LED
Housing material	Plastic
Housing color	white
Protection type (IP)	IP40
Impact resistance (IK)	5
Certification	CE, WEEE
Insulation class	2
Monitoring	SelfControl (SC)
Bridging time	3 h
Battery	6,4 V 1,2 Ah/
Power max.	4,2 W
Power DS	3,4 W
Power BS	0,9 W



Ambient temperature DS	-5 °C - 40 °C
Ambient temperature BS	-5 °C - 40 °C
Depth	80.9 mm
Width	317.5 mm
Height	233.5 mm
Weight	0.96
Weight incl. packaging	1.45
Customs tariff number	94056120
EAN	4260766556227

TECHNICAL DRAWING

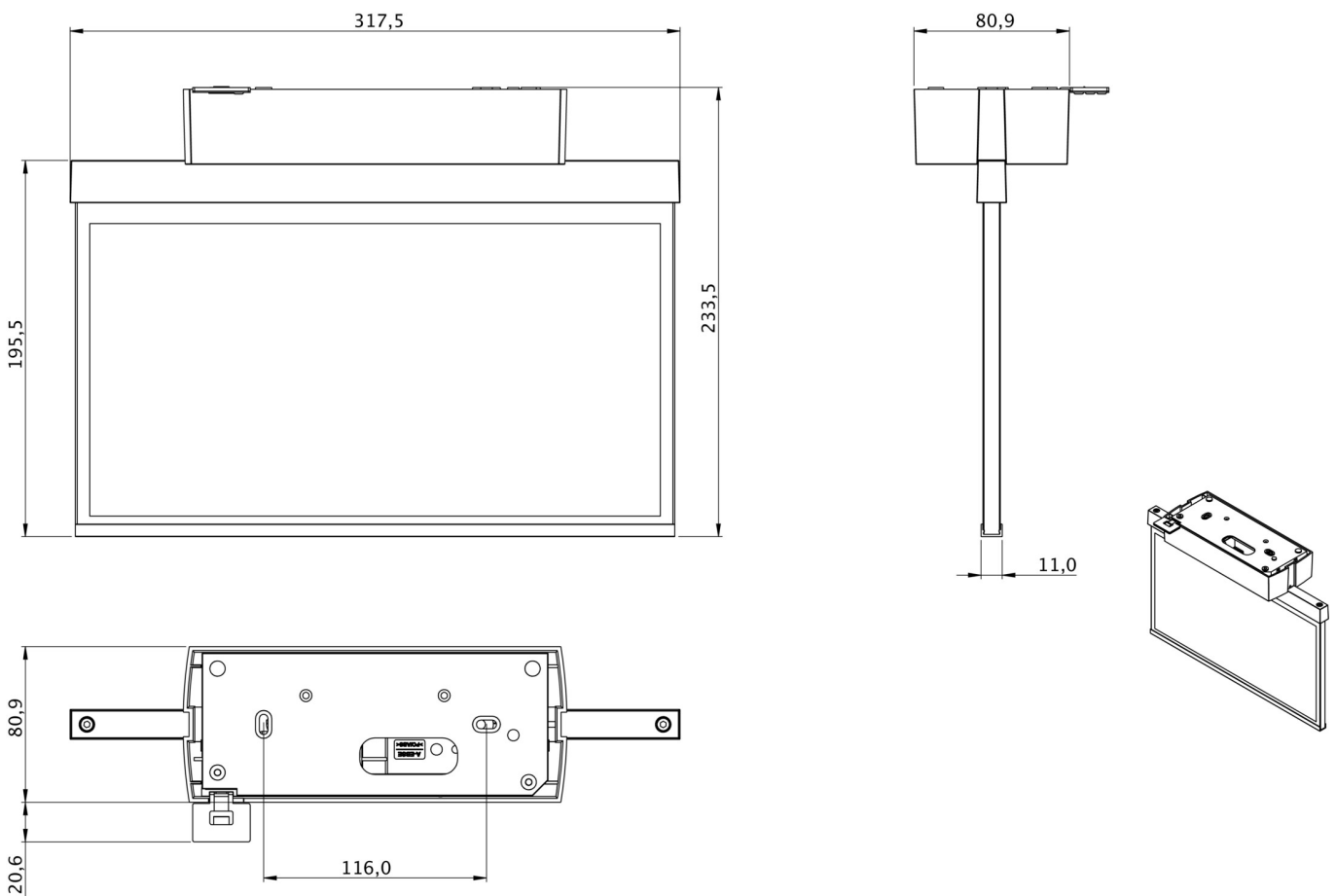

As of: 23.08.2024 - Subject to technical changes and errors.