



Art.-Nr: GAMW408WL
Exit sign Single Battery
Wall, Wireless Professional (WL), 8 h, 22 m, IP40, Plastic, white

Emergency exit sign luminaire with plastic pane for surface mounting on the wall and for identifying emergency and escape routes. It is based on the design of the A series luminaire family, which provides solutions for any mounting and has won the German Design Award for its uniform, straight-line design. The luminaires are equipped with modern LED illuminants and provide flexibility through their interchangeable pictograms.

Wireless central control and monitoring for large installations of up to 50,000 luminaires with Wireless Professional. Display edge luminaire with integrated light distribution for even pictogram illumination. Suited to inscription on one or two sides. Planning certainty is provided by tool-free, variable use of the pictograms on site. A set of pictograms corresponding to DIN ISO 7010 (arrow to the right, left, up and down) is supplied as standard.



More information

www.rp-group.com/en/item/GAMW408WL



TECHNICAL DATA

Luminaire type	Exit sign
Mounting	Wall
Recognition distance	22 m
Pictograph	Set
Illuminant	LED
Housing material	Plastic
Housing color	white
Protection type (IP)	IP40
Impact resistance (IK)	5
Certification	WEEE, CE
Insulation class	2
Supply	Single Battery
Monitoring	Wireless Professional (WL)
Bridging time	8 h
Battery	6,4 V 1,2 Ah/



Operating mode	Standby circuit / permanent circuit
Input voltageAC	230 V
Input frequency	50 Hz
Power max.	4,7 W
Power DS	3,5 W
Power BS	0,8 W
Ambient temperature DS	-5 °C - 40 °C
Ambient temperature BS	-5 °C - 40 °C
Depth	56.1 mm
Width	241.5 mm
Height	152.2 mm
Weight	0.83
Weight incl. packaging	1.19
Connection cross-section	2.5 mm ²
Switching input	Yes
Emergency light blocking	Yes
Battery connection	Connector
Dimming function	Yes
Customs tariff number	94056120
EAN	4260766551161



TECHNICAL DRAWING

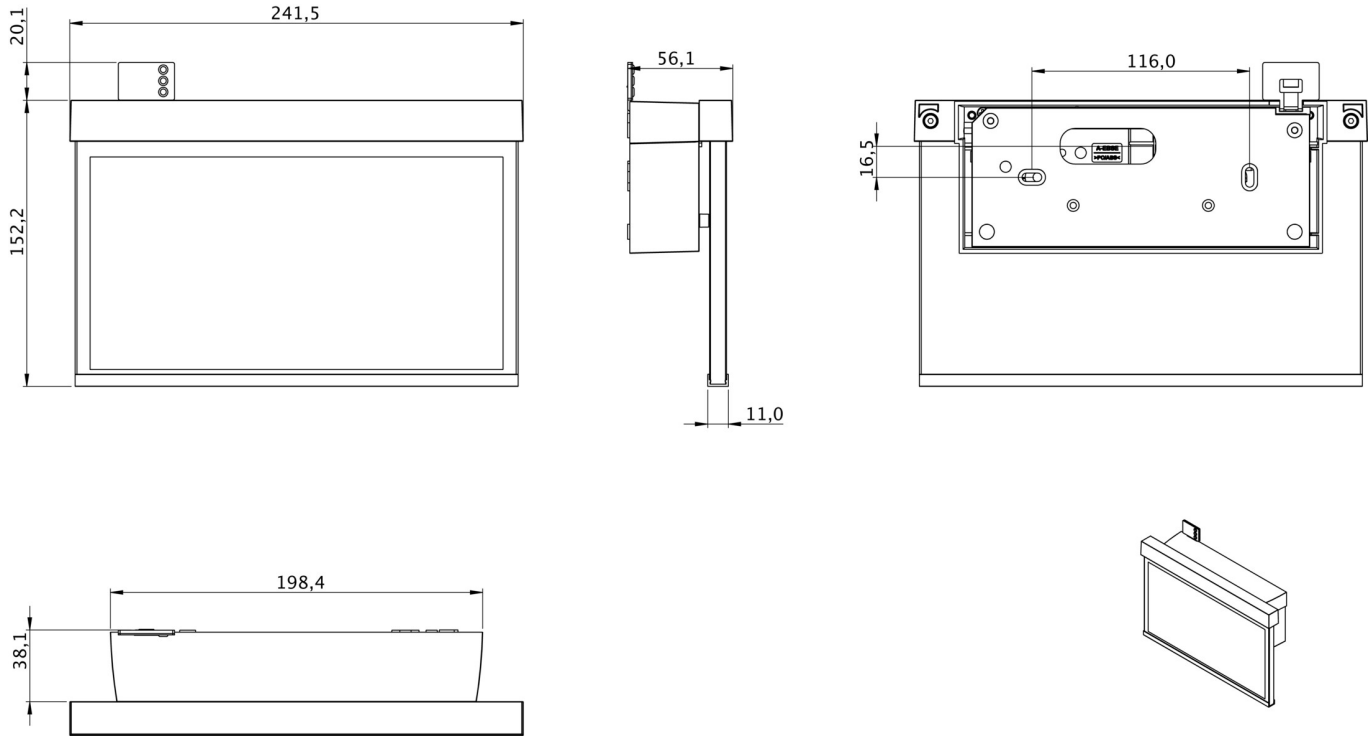

As of: 23.08.2024 - Subject to technical changes and errors.