



Art.-Nr: GABD408WL
Exit sign Single Battery
Ceiling, Wireless Professional (WL), 8 h, 40 m, IP40, Plastic, white

Emergency exit sign luminaire with plastic pane for surface mounting on the ceiling and for identifying emergency and escape routes. It is based on the design of the A series luminaire family, which provides solutions for any mounting and has won the German Design Award for its uniform, straight-line design. The luminaires are equipped with modern LED illuminants and provide flexibility through their interchangeable pictograms.

Wireless central control and monitoring for large installations of up to 50,000 luminaires with Wireless Professional. Two requested pictograms (arrow to the right, left, up, down or white) are supplied as standard.



More information

www.rp-group.com/en/item/GABD408WL



TECHNICAL DATA

Luminaire type	Exit sign
Mounting	Ceiling
Recognition distance	40 m
Pictograph	acc. to Specification
Housing material	Plastic
Housing color	white
Protection type (IP)	IP40
Impact resistance (IK)	5
Certification	WEEE, CE
Insulation class	2
Supply	Single Battery
Monitoring	Wireless Professional (WL)
Bridging time	8 h
Battery	6,4 V 1,2 Ah/
Operating mode	Standby circuit / permanent circuit
Input voltageAC	230 V
Input frequency	50 Hz



Power max.	5 W
Power DS	3,8 W
Power BS	0,8 W
Ambient temperature DS	-5 °C - 40 °C
Ambient temperature BS	-5 °C - 40 °C
Depth	80.9 mm
Width	417.5 mm
Height	245.5 mm
Weight	1.42
Weight incl. packaging	2.07
Connection cross-section	2.5 mm ²
Switching input	Yes
Emergency light blocking	Yes
Battery connection	Connector
Dimming function	Yes
Customs tariff number	94056120
EAN	4260766551093



TECHNICAL DRAWING

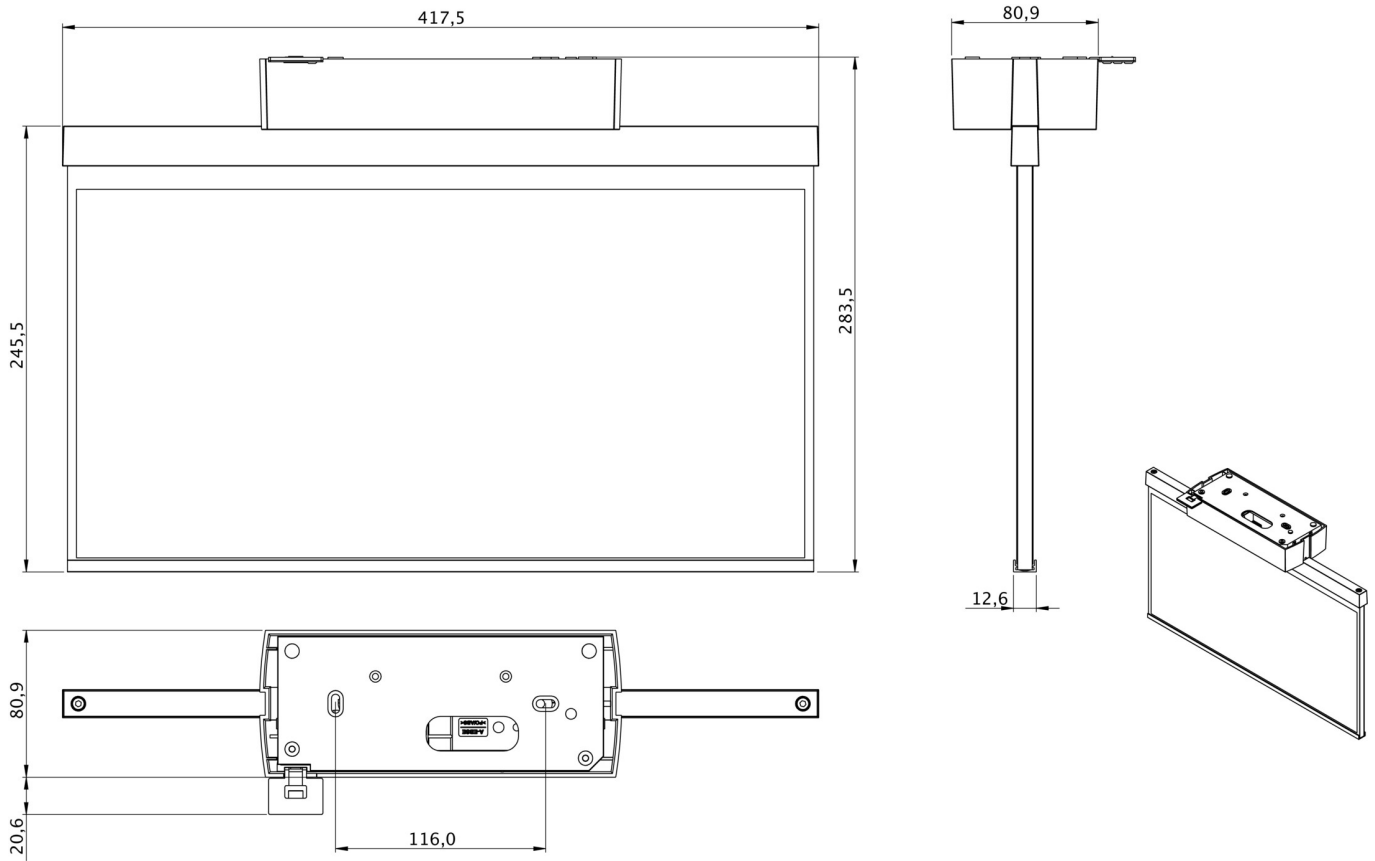

As of: 23.08.2024 - Subject to technical changes and errors.