



**Art.-Nr: FMW408WL-AZ**  
**Exit sign Single Battery**  
**Wall mounting, Wireless Professional (WL), 8 h, 20 m, IP65,**  
**Zinc die-cast, white**

Robust zinc die-cast emergency exit sign luminaire for mounting on the wall and for identifying emergency and escape routes.

The pictogram is fitted on the inside where it is protected by a transparent pane.

Wireless central control and monitoring for large installations of up to 50,000 luminaires with Wireless Professional. The innovative integrated lens holder with a rapid fitting fixture permits the flexible use of various lens types. Using the right lens allows the distribution of light to be matched perfectly to the application and simplifies illumination which satisfies all relevant standards. A round lens and hall lens are supplied with every luminaire, allowing it to be adapted perfectly to the respective mounting situation. Other lenses, such as a spotlight lens, beam lens or H lens, are available as options.



More information

[www.rp-group.com/en/item/FMW408WL-AZ](http://www.rp-group.com/en/item/FMW408WL-AZ)



## TECHNICAL DATA

Luminaire type	Exit sign
Mounting	Wall mounting
Recognition distance	20 m
Pictograph	Set
Illuminant	LED
Housing material	Zinc die-cast
Housing color	white
Protection type (IP)	IP65
Impact resistance (IK)	8
Certification	WEEE, CE, D-Sign
Insulation class	1
Supply	Single Battery
Monitoring	Wireless Professional (WL)
Bridging time	8 h
Battery	LiFePO4 6,4 V/3,3 Ah
Operating mode	Standby circuit / permanent circuit



Input voltageAC	230 V
Input frequency	50 Hz
Power max.	4,6 W
Power DS	2,6 W
Power BS	0,8 W
Ambient temperature DS	-5 °C - 40 °C
Ambient temperature BS	-5 °C - 40 °C
Depth	58 mm
Width	262 mm
Height	188 mm
Weight	2.12
Weight incl. packaging	2.22
Connection cross-section	2.5 mm <sup>2</sup>
Switching input	Yes
Emergency light blocking	Yes
Battery connection	Connector
Dimming function	Yes
Customs tariff number	94056180
EAN	4260766557262



## TECHNICAL DRAWING

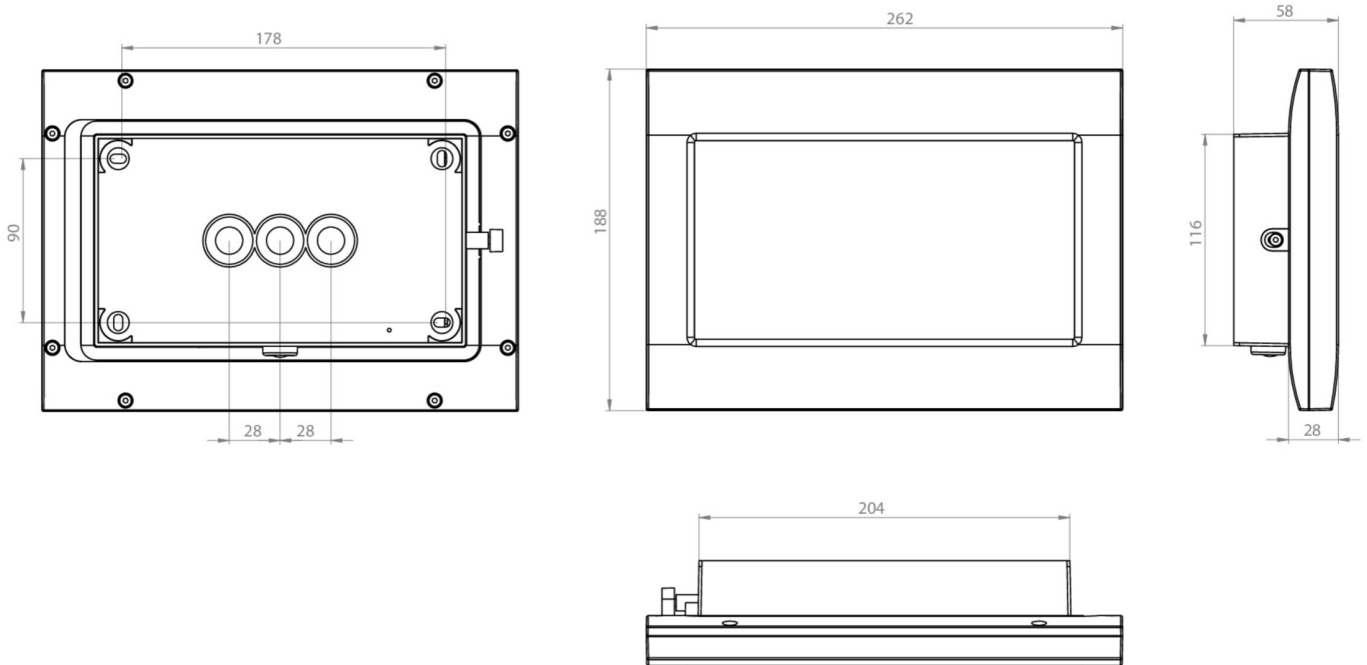

## ACCESSORY LIST

- FMWA001 -
- FMDA001 -
- FMDA002-AZ -
- FMFH -
- FMDA001-AZ -
- FMDA002 -

As of: 28.10.2024 - Subject to technical changes and errors.