



Art.-Nr: FMW403SC-AZ

Exit sign

Wall, SelfControl (SC), 3 h, 20 m, IP65, Zinc die-cast, Anthracite

Robust zinc die-cast emergency exit sign luminaire for mounting on the wall and for identifying emergency and escape routes.

The pictogram is fitted on the inside where it is protected by a transparent pane.

Automatic monitoring of safety luminaire with SelfControl. The innovative integrated lens holder with a rapid fitting fixture permits the flexible use of various lens types. Using the right lens allows the distribution of light to be matched perfectly to the application and simplifies illumination which satisfies all relevant standards. A round lens and hall lens are supplied with every luminaire, allowing it to be adapted perfectly to the respective mounting situation. Other lenses, such as a spotlight lens, beam lens or H lens, are available as options.



More information

www.rp-group.com/en/item/FMW403SC-AZ



TECHNICAL DATA

Luminaire type	Exit sign
Mounting	Wall
Recognition distance	20 m
Pictograph	Set
Illuminant	LED
Housing material	Zinc die-cast
Housing color	Anthracite
Protection type (IP)	IP65
Impact resistance (IK)	8
Certification	WEEE, CE, D-Sign
Insulation class	1
Monitoring	SelfControl (SC)
Bridging time	3 h
Battery	6,4 V 1,2 Ah/
Power max.	3,9 W
Power DS	3,0 W
Power BS	0,9 W



Ambient temperature DS	-5 °C - 40 °C
Ambient temperature BS	-5 °C - 40 °C
Depth	58 mm
Width	262 mm
Height	188 mm
Weight	2.04
Weight incl. packaging	2.14
Customs tariff number	94056180
EAN	4260766556128

TECHNICAL DRAWING

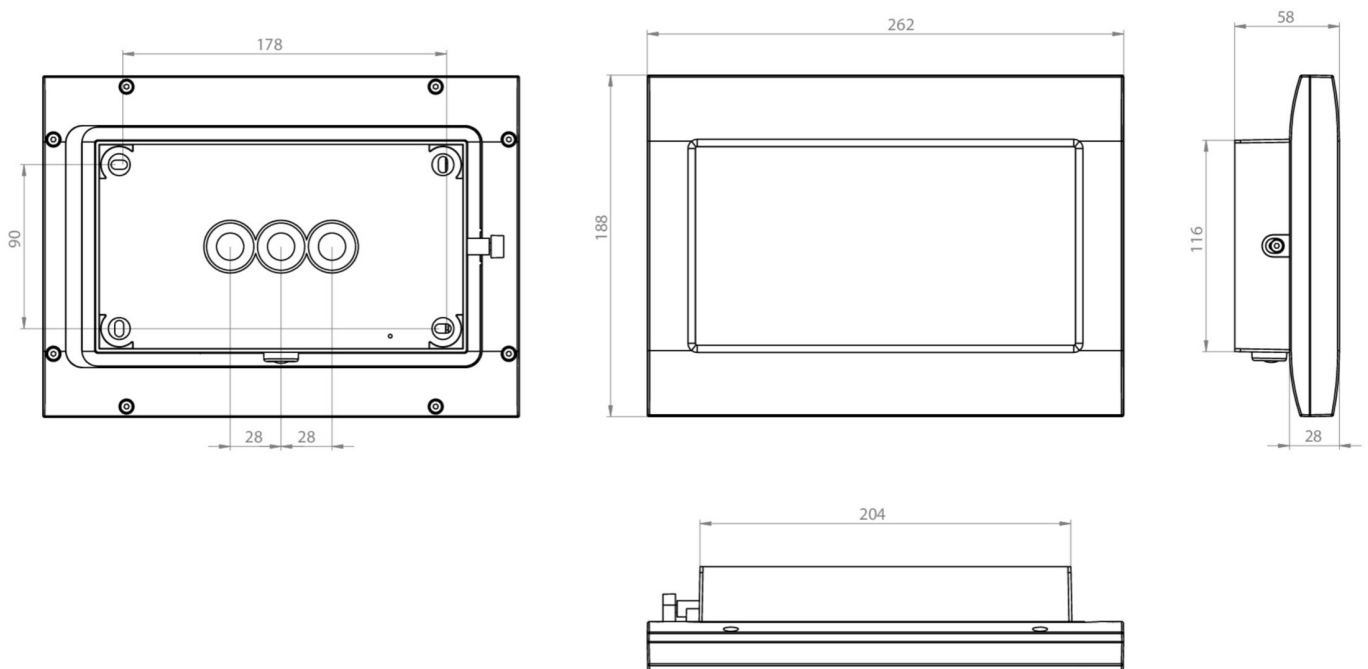

ACCESSORY LIST

- FMDA002-AZ -
- FMDA001-AZ -
- FMFH -
- FMDA002 -

As of: 23.08.2024 - Subject to technical changes and errors.