



Art.-Nr: AXCC408WL
Exit sign Single Battery
Ceiling mounting, Wireless Professional (WL), 8 h, 30 m,
IP20, Zinc die-cast, white

Modern zinc die-cast emergency exit sign luminaire with wire suspension for recessed mounting in the ceiling. Escape and emergency routes can be identified on either one or two sides.

It is part of the A series luminaire family, which provides solutions for any mounting and has won the German Design Award for its uniform, straight-line design.

Wireless central control and monitoring for large installations of up to 50,000 luminaires with Wireless Professional. The innovative integrated lens holder with a rapid fitting fixture permits the flexible use of various lens types. Using the right lens allows the distribution of light to be matched perfectly to the application and simplifies illumination which satisfies all relevant standards. A round lens and hall lens are supplied with every luminaire, allowing it to be adapted perfectly to the respective mounting situation. Other lenses, such as a spotlight lens, beam lens or H lens, are available as options.



More information

www.rp-group.com/en/item/AXCC408WL



TECHNICAL DATA

Luminaire type	Exit sign
Mounting	Ceiling mounting
Recognition distance	30 m
Pictograph	Set
Illuminant	LED
Housing material	Zinc die-cast
Housing color	white
Protection type (IP)	IP20
Certification	WEEE, CE, ENEC
Insulation class	2
Supply	Single Battery
Monitoring	Wireless Professional (WL)
Bridging time	8 h
Battery	6,4 V 1,2 Ah/



Operating mode	Standby circuit / permanent circuit
Input voltageAC	230 V
Input frequency	50 Hz
Power max.	5,6 W
Power DS	4,5 W
Power BS	0,8 W
Ambient temperature DS	-5 °C - 40 °C
Ambient temperature BS	-5 °C - 40 °C
Depth	80 mm
Width	312 mm
Height	181 mm
Installation length	176 mm
Installation width	68 mm
Installation height	40 mm
Weight	2.05
Weight incl. packaging	2.54
Connection cross-section	2.5 mm ²
Switching input	Yes
Emergency light blocking	Yes
Battery connection	Connector
Dimming function	Yes
Customs tariff number	94056180
EAN	4260682153654



TECHNICAL DRAWING

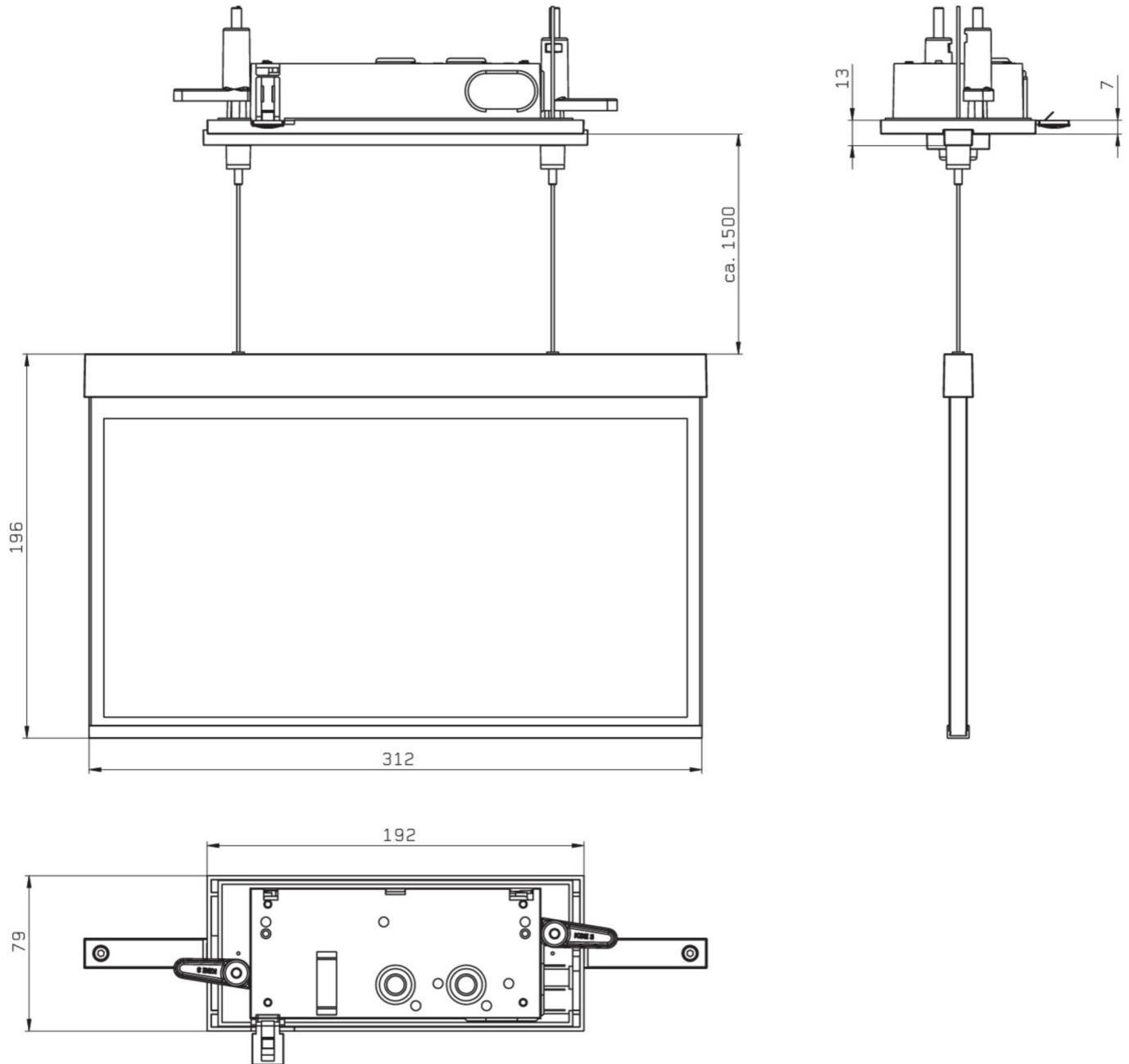

ACCESSORY LIST

AM-XBE -

LFP3212.K-SET-2AKKU - CS_VALUE_BatteryTechnology. Battery



RELATED PRODUCTS

Art.-No.	Image	Monitoring	Supply	Color	Investment	Automatic log	Maintenance level	Remote maintenance	max. luminaires	Single luminaire monitoring
AXCC408WL-AZ		Wireless Professional (WL)	Single battery	RAL 7016	€€	yes	low	yes	1,000 per system	central
AXCC408WL-E		Wireless Professional (WL)	Single battery	Edelstahl	€€	yes	low	yes	1,000 per system	central

As of: 23.08.2024 - Subject to technical changes and errors.