



Art.-Nr: ASMU413WB
Exit sign Single Battery
Universal, Wireless Basic (WB), 3 h, 22 m, IP40, Aluminium,
Anodised aluminium

Multi-functional aluminium emergency exit sign luminaire for universal mounting. As a result of the clever structure, the recesses for cable entry and fastening are integrated, both for ceiling and wall mounting. Visually appealing side parts cover the lock mechanism so that the luminaire conveys a harmonious and fully closed impression.

Wireless control and monitoring for small installations of up to 50 luminaires with Wireless Basic. The innovative integrated lens holder with a rapid fitting fixture permits the flexible use of various lens types. Using the right lens allows the distribution of light to be matched perfectly to the application and simplifies illumination which satisfies all relevant standards. A round lens and hall lens are supplied with every luminaire, allowing it to be adapted perfectly to the respective mounting situation. Other lenses, such as a spotlight lens, beam lens or H lens, are available as options.



More information

www.rp-group.com/en/item/ASMU413WB



TECHNICAL DATA

Luminaire type	Exit sign
Mounting	Universal
Recognition distance	22 m
Pictograph	Set
Illuminant	LED
Housing material	Aluminium
Housing color	Anodised aluminium
Protection type (IP)	IP40
Impact resistance (IK)	3
Certification	WEEE, CE, ENEC, TÜV Rheinland Type approved
Insulation class	1
Supply	Single Battery
Monitoring	Wireless Basic (WB)
Bridging time	3 h
Battery	/



Operating mode	Standby circuit / permanent circuit
Input voltage AC	230 V
Input frequency	50 / 60 Hz
Input voltage DC	- V
Power max.	5,3 W
Power DS	3,9 W
Power BS	1,5 W
Ambient temperature DS	-5 °C - 40 °C
Ambient temperature BS	-5 °C - 40 °C
Depth	54 mm
Width	277 mm
Height	184 mm
Weight	0.81
Weight incl. packaging	0.98
Connection cross-section	2.5 mm ²
Switching input	Yes
Emergency light blocking	No
Battery connection	Connector
Dimming function	No
Luminous flux mains	190 lm
Luminous flux emergency	190 lm
Customs tariff number	94056180
EAN	4260766559891

TECHNICAL DRAWING

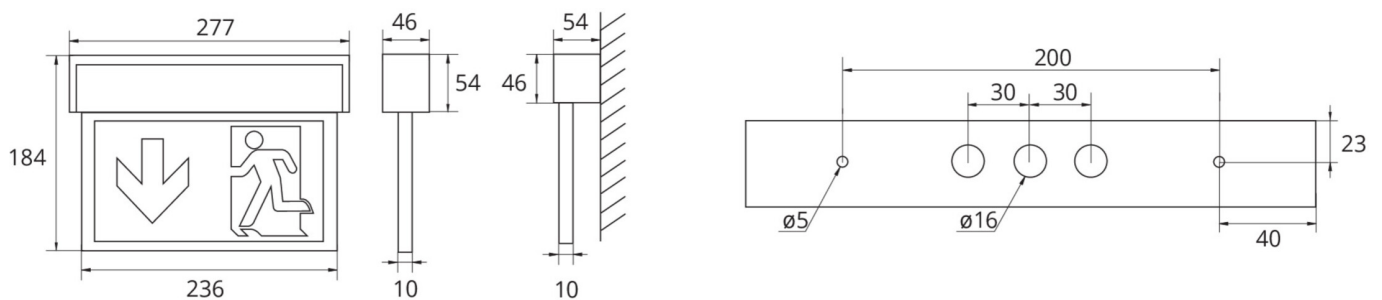



ACCESSORY LIST

DSA - Wire suspension

2PS-EB - Pendant

As of: 23.08.2024 - Subject to technical changes and errors.