



Art.-Nr: AME408SC-AZ

Exit sign

Ceiling mounting, SelfControl (SC), 8 h, 22 m, IP20, Zinc die-cast, Anthracite

Modern zinc die-cast emergency exit sign luminaire for recessed mounting in the ceiling. With an installation diameter of 68 mm, this luminaire can be easily integrated into many environments. Escape and emergency routes can be identified on either one or two sides.

It is part of the A series luminaire family, which provides solutions for any mounting and has won the German Design Award for its uniform, straight-line design.

Automatic monitoring of safety luminaire with SelfControl. The innovative integrated lens holder with a rapid fitting fixture permits the flexible use of various lens types. Using the right lens allows the distribution of light to be matched perfectly to the application and simplifies illumination which satisfies all relevant standards. A round lens and hall lens are supplied with every luminaire, allowing it to be adapted perfectly to the respective mounting situation. Other lenses, such as a spotlight lens, beam lens or H lens, are available as options.



More information

www.rp-group.com/en/item/AME408SC-AZ



TECHNICAL DATA

Luminaire type	Exit sign
Mounting	Ceiling mounting
Recognition distance	22 m
Pictograph	Set
Illuminant	LED
Housing material	Zinc die-cast
Housing color	Anthracite
Protection type (IP)	IP20
Impact resistance (IK)	≥ 3
Certification	WEEE, CE
Insulation class	2
Monitoring	SelfControl (SC)
Bridging time	8 h
Battery	LiFePO4 6,4 V/1,2 Ah
Power max.	2,6 W
Power DS	1,7 W
Power BS	0,9 W



Ambient temperature DS	-5 °C - 40 °C
Ambient temperature BS	-5 °C - 40 °C
Depth	92 mm
Width	236 mm
Height	194 mm
Installation dimensions Diameter	68 mm
Weight	1.2
Weight incl. packaging	1.56
Customs tariff number	94056080
EAN	4262483021927

TECHNICAL DRAWING

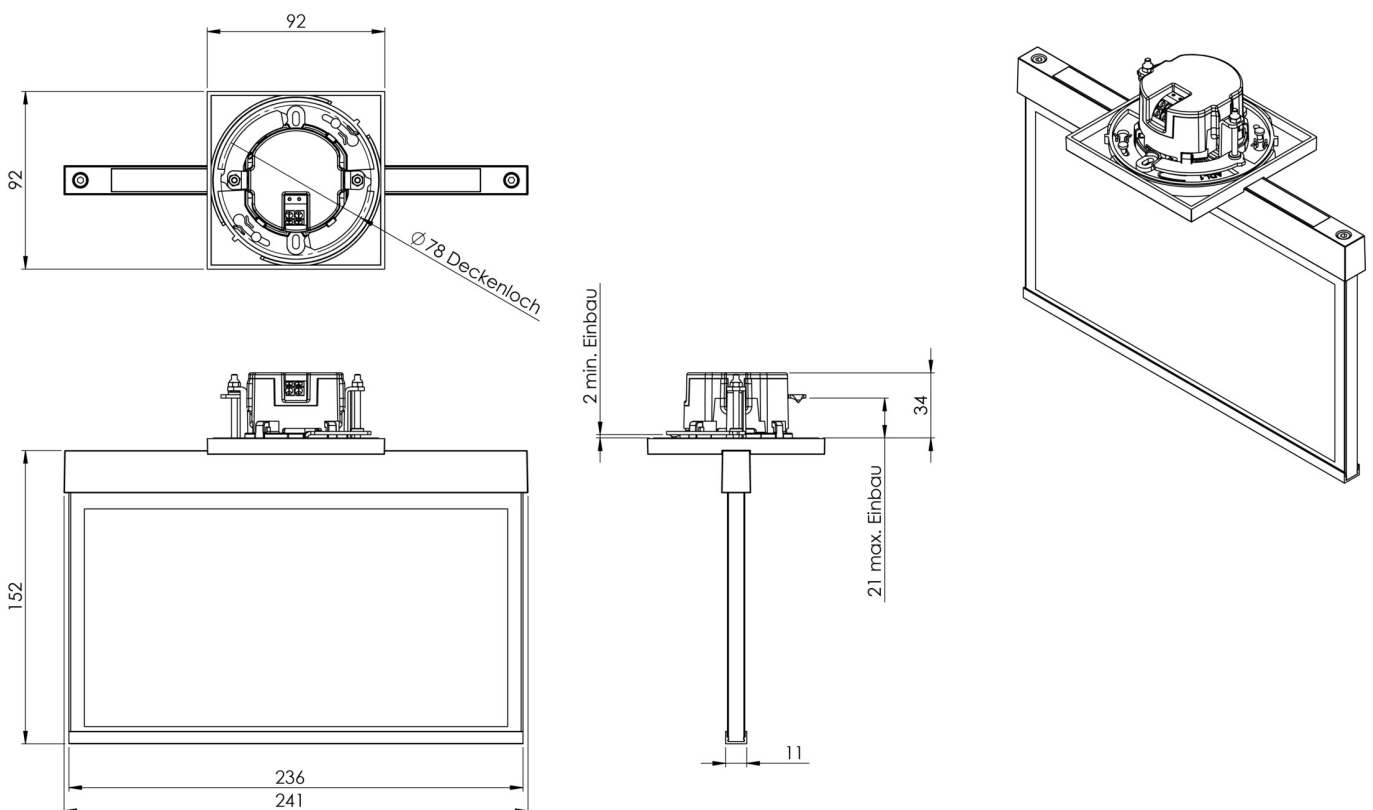

As of: 31.10.2024 - Subject to technical changes and errors.