



Art.-Nr: AIW408WL
Exit sign Single Battery
Wall, Wireless Professional, 8 h, 15 m, IP40, Zinc die-cast, white

The AIW is a zinc-diecast exit sign for wall mounting and for the marking of escape routes. It is part of a complete luminaire series, which features solutions for every mounting situation and was honored with the German Design Award. Luminaires of the A-Series are equipped with modern LED illuminants and offer flexibility with changeable pictograms.

LED exit sign according to EN 60598-1, EN 60598-2-22, EN 7010 and EN 1838



More information



TECHNICAL DATA

Luminaire type	Exit sign
Mounting	Wall
Recognition distance	15 m
Pictograph	Set
Illuminant	LED
Housing material	Zinc die-cast
Housing color	white
Protection type (IP)	IP40
Impact resistance (IK)	≥ 3
Certification	CE, WEEE
Insulation class	2
Supply	Single Battery
Monitoring	Wireless Professional
Bridging time	8 h
Battery	LFP3212.K-SET-2AKKU
Operating mode	Standby circuit / permanent circuit
Input voltage AC	230 V
Input frequency	50 Hz
Power max.	3,7 W
Power DS	2,6 W



Power BS	0,8 W
Ambient temperature DS	-5 °C - 40 °C
Ambient temperature BS	-5 °C - 40 °C
Depth	55 mm
Width	193 mm
Height	120 mm
Installation dimensions Diameter	68 mm
Weight	1.22
Weight incl. packaging	1.47
Connection cross-section	2.5 mm ²
Switching input	Yes
Emergency light blocking	Yes
Battery connection	Connector
Dimming function	Yes
Customs tariff number	94056180
EAN	4260766552984



TECHNICAL DRAWING

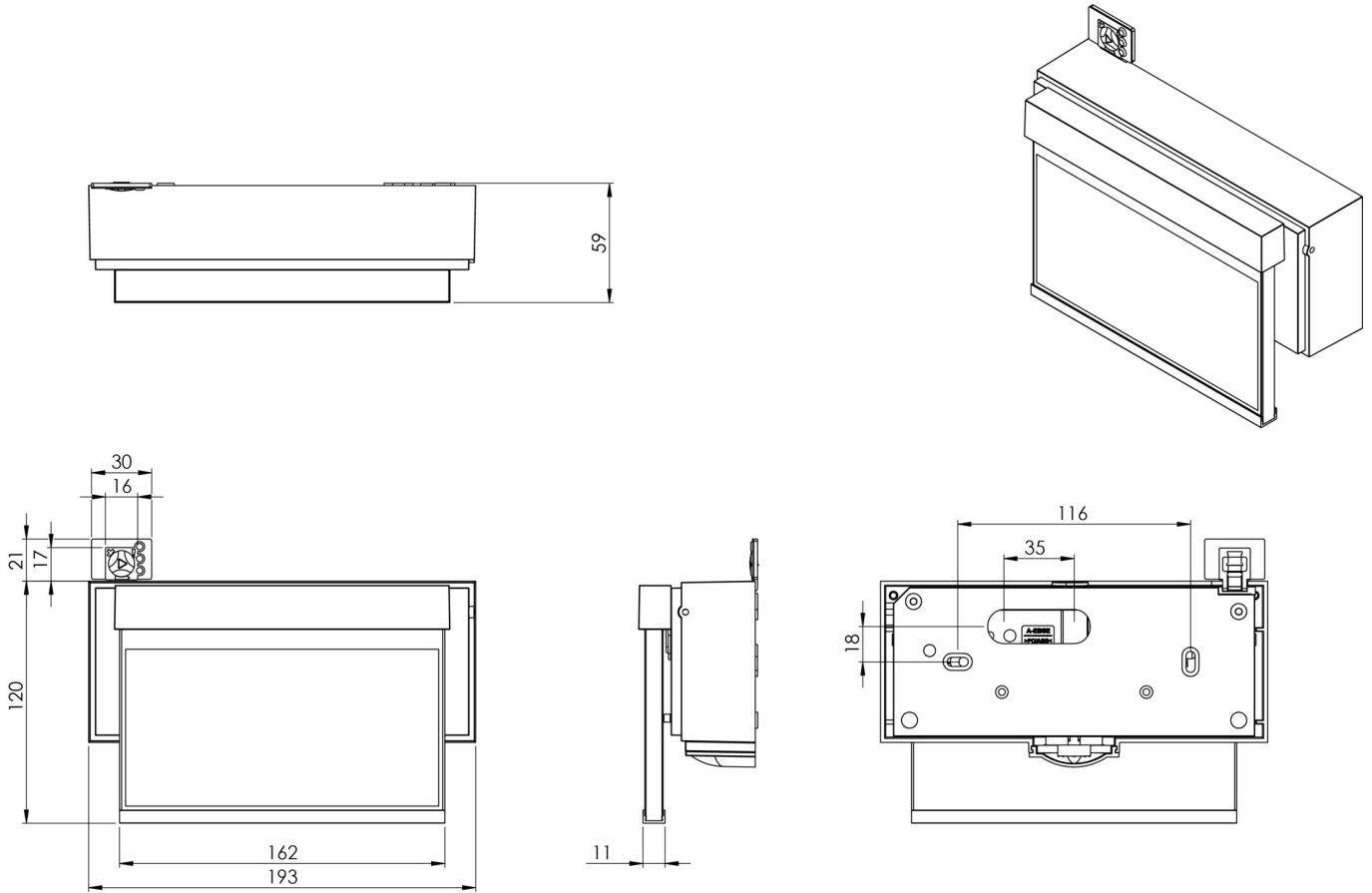

As of: 16.07.2024 - Subject to technical changes and errors.