



**Art.-Nr: AIW408SC-E**

**Exit sign**

**Wall mounting, SelfControl (SC), 8 h, 15 m, IP40, Zinc die-cast, Stainless steel**

Modern zinc die-cast emergency exit sign luminaire for surface mounting on the wall and for identifying emergency and escape routes.

It is part of the A series luminaire family, which provides solutions for any mounting and has won the German Design Award for its uniform, straight-line design.

Automatic monitoring of safety luminaire with SelfControl. The innovative integrated lens holder with a rapid fitting fixture permits the flexible use of various lens types. Using the right lens allows the distribution of light to be matched perfectly to the application and simplifies illumination which satisfies all relevant standards. A round lens and hall lens are supplied with every luminaire, allowing it to be adapted perfectly to the respective mounting situation. Other lenses, such as a spotlight lens, beam lens or H lens, are available as options.



More information

[www.rp-group.com/en/item/AIW408SC-E](http://www.rp-group.com/en/item/AIW408SC-E)



**TECHNICAL DATA**

Luminaire type	Exit sign
Mounting	Wall mounting
Recognition distance	15 m
Pictograph	Set
Illuminant	LED
Housing material	Zinc die-cast
Housing color	Stainless steel
Protection type (IP)	IP40
Impact resistance (IK)	≥ 3
Certification	CE, WEEE
Insulation class	2
Monitoring	SelfControl (SC)
Bridging time	8 h
Battery	LiFePO4 6,4 V/1,2 Ah
Power max.	2,6 W



Power DS	1,7 W
Power BS	0,9 W
Ambient temperature DS	-5 °C - 40 °C
Ambient temperature BS	-5 °C - 40 °C
Depth	55 mm
Width	193 mm
Height	120 mm
Installation dimensions Diameter	68 mm
Weight	1.15
Weight incl. packaging	1.4
EAN	4262483021545

## TECHNICAL DRAWING

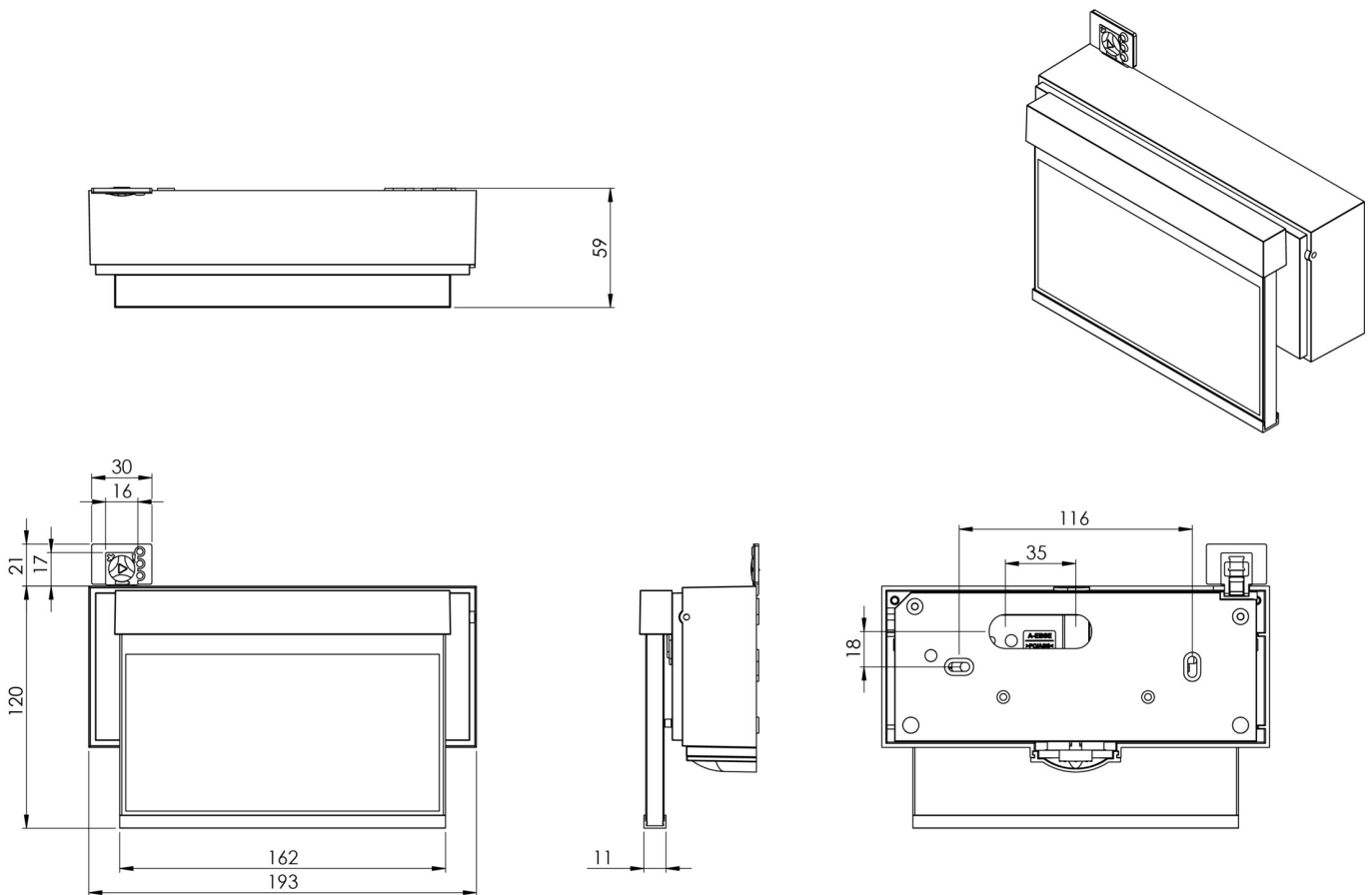

As of: 31.10.2024 - Subject to technical changes and errors.