



Art.-Nr: AIEP401SC

Exit sign

Ceiling mounting, SelfControl (SC), 1 h, 15 m, IP20, Zinc die-cast, white

Modern zinc die-cast emergency exit sign luminaire with pendant for recessed mounting in the ceiling. With an installation diameter of 68 mm, this luminaire can be easily integrated into many environments. Escape and emergency routes can be identified on either one or two sides.

It is part of the A series luminaire family, which provides solutions for any mounting and has won the German Design Award for its uniform, straight-line design.

Automatic monitoring of safety luminaire with SelfControl. The innovative integrated lens holder with a rapid fitting fixture permits the flexible use of various lens types. Using the right lens allows the distribution of light to be matched perfectly to the application and simplifies illumination which satisfies all relevant standards. A round lens and hall lens are supplied with every luminaire, allowing it to be adapted perfectly to the respective mounting situation. Other lenses, such as a spotlight lens, beam lens or H lens, are available as options.



More information

www.rp-group.com/en/item/AIEP401SC



TECHNICAL DATA

Luminaire type	Exit sign
Mounting	Ceiling mounting
Recognition distance	15 m
Pictograph	Set
Illuminant	LED
Housing material	Zinc die-cast
Housing color	white
Protection type (IP)	IP20
Impact resistance (IK)	≥ 3
Certification	WEEE, CE
Insulation class	2
Monitoring	SelfControl (SC)
Bridging time	1 h
Battery	6,4 V 1,2 Ah/



Power max.	3,5 W
Power DS	2,6 W
Power BS	0,9 W
Ambient temperature DS	-5 °C - 40 °C
Ambient temperature BS	-5 °C - 40 °C
Depth	92 mm
Width	167 mm
Height	259 mm
Installation dimensions Diameter	68 mm
Weight	0.85
Weight incl. packaging	1.1
Customs tariff number	94056180
EAN	4260766554278



TECHNICAL DRAWING

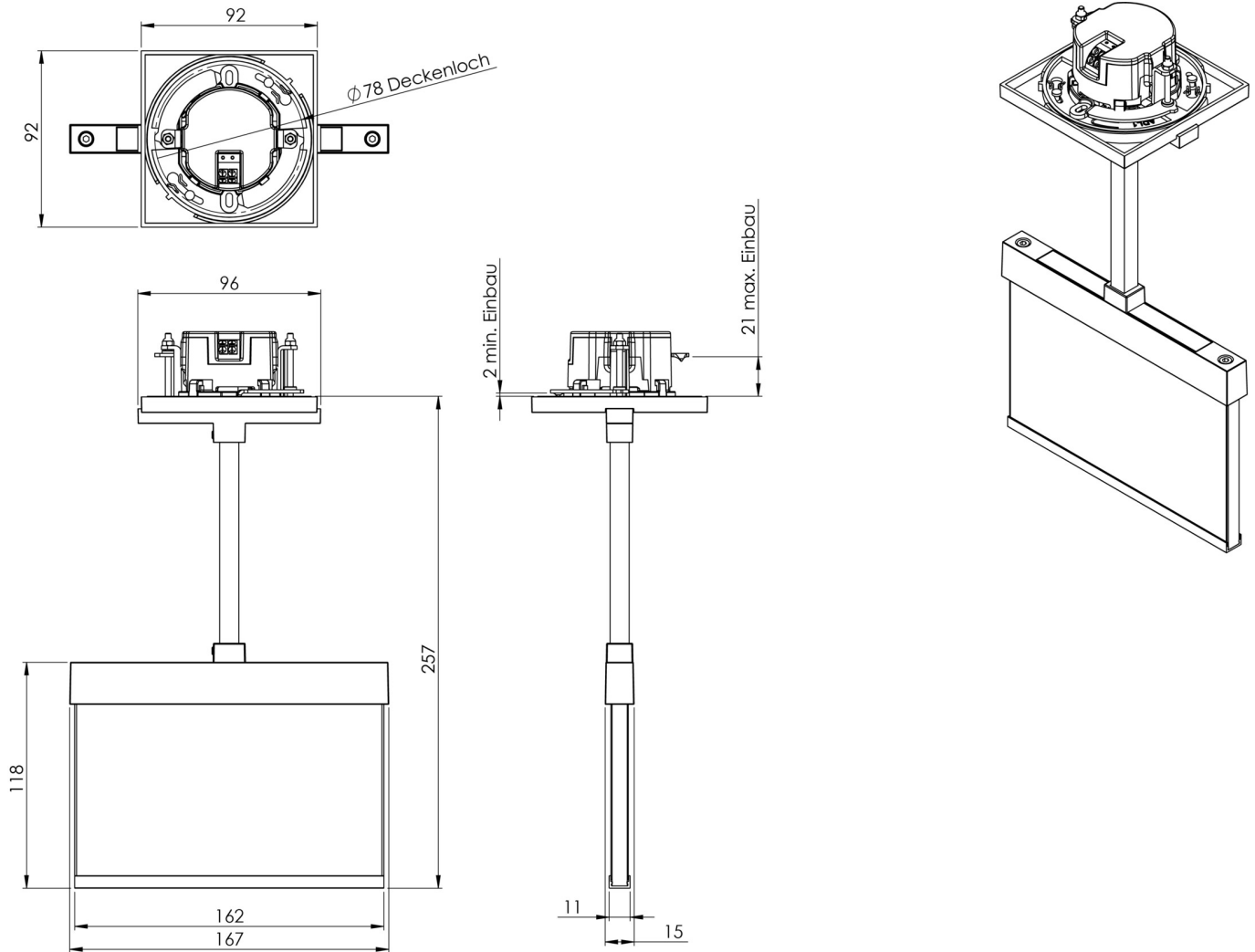

ACCESSORY LIST

AM-X-PKG -

As of: 23.08.2024 - Subject to technical changes and errors.