

Central Power Supply System with Central Battery and Microprocessor-Based Function Control System

multiControl plus

*



Bauart geprüft
Sicherheit
Regelmäßige
Produktions-
überwachung

www.tuv.com
ID 1111212721

Abbildung

Customer order No.:

Manufacturer No.:

Commissioning / Object:

Device No:

Contents

1	General	5
1.1	Further applicable documents.....	5
1.2	Liability and warranty.....	5
1.3	Copyright protection.....	5
1.4	Spare parts.....	5
1.5	Disposal.....	5
2	Safety	6
2.1	Content of the instruction manual.....	6
2.2	Changes and modifications of the system.....	6
2.3	Responsibility of the operator.....	6
2.4	Staff requirements.....	6
2.5	Safety at work.....	7
2.6	Personal protection equipment.....	7
3	Preface	8
3.1	Installation location and environmental conditions.....	8
4	Danger and information signs	9
5	Scope of delivery	10
6	System overview	11
6.1	Overview electronic housing back view.....	12
7	Mounting and installation of the power supply system	13
7.1	Connection of the charger and switch unit.....	13
7.1.1	Mains connection (terminal X01).....	13
7.1.2	Battery fuse.....	13
7.1.3	Battery connection (terminal X21).....	13
7.1.4	Outgoing substation - ABUS (terminal X3x).....	14
7.1.5	Outgoing sub-distributor - ABUV (terminal X4x).....	14
7.1.6	Outgoing sub-distributor - single wire supply - ABUV-E (terminal X4x).....	14
7.1.7	SAM24 switching inputs (terminal X03).....	15
7.1.8	Ethernet interface (terminal X10).....	15
7.1.9	Switch contacts (terminal block X02).....	16
7.1.10	2nd error messages (terminal X18) (optional).....	17
7.1.11	Error messages 2nd IO-module (terminal X19) (optional).....	17
7.1.12	Critical circuit (terminal block X22 F7/F8, optional CCIF).....	18
7.1.13	Bus-compatible modules (terminal block X07).....	18
7.1.14	Output circuits (terminal block X30).....	19
7.2	Mounting and installation of the battery system.....	20
7.2.1	Mounting.....	20
7.2.2	Battery connection.....	21
7.2.3	Connection of the battery blocks.....	22
8	Commissioning of the power supply system	23
9	Setting up your system	24
9.1	General operating instructions.....	24
9.2	System state.....	25
9.3	Selecting circuits and checking their state.....	26

9.4	Viewing and changing of the circuit setup	27
9.4.1	Setting the circuit monitoring mode	28
9.4.2	Programming the SAM-module	28
10	Tests.....	29
10.1	Execution of a function test	29
10.2	Programming automatic function tests	30
10.2.1	Setting the schedule.....	30
10.2.2	Setting the current monitor window	30
10.2.3	Activating/deactivating the preheating phase and finishing the programming.....	31
10.3	Execution of a capacity test.....	31
10.4	Test results	32
10.5	Reset errors.....	32
10.6	Checking the state of the charger	33
10.7	System information & system log	33
11	De-energising the power supply.....	36
12	The central control and monitoring unit	37
12.1	Menu - quick reference guide	38
13	Operation, maintenance and servicing of the batteries.....	39
13.1	Charging and discharging	39
13.2	Recommended working temperature.....	39
13.3	Servicing and inspections	40
13.4	First inspection	40
13.5	Repeating inspection.....	41
13.6	Inspection before commissioning.....	42
13.7	Procedure in case of failure.....	43
13.8	Decommissioning, storing and transport	43
14	General information on your system	44
14.1	Used battery type.....	44
15	Technical data	45
16	Module descriptions.....	47
16.1	Electric circuit module DCM	47
16.2	Electric circuit module DCM12E.....	47
16.3	Charger module LDM	48
16.4	Input/Output-module	48
16.5	Switch query module SAM24 (optional).....	49
16.6	multiControl <i>plus</i> Line Monitor MC-LM (optional).....	49
16.7	PC230 (optional)	50
16.8	MCT15(S) / MCT15U(S) (optional)	50
17	Connection examples	51
18	Revision history.....	57
19	Circuit table.....	58
20	Measurement protocols battery.....	61

Central Power Supply System multiControl *plus*

Setup & Commissioning

1 General

This instruction manual is aimed at electrically skilled people according to DIN VDE 0105 or authorised technical staff and explains the safe and professional handling of the central battery system. The general safety regulations and the local accident prevention regulations which are valid for the area of use as well as safety instructions have to be observed. The instruction manual, especially the chapter safety, has to be read completely prior to any works on the system.

1.1 Further applicable documents

Components from other manufacturers are mounted in the systems. The manufacturers of these components carried out a hazard assessment and declared their compliance with existing European and national regulations.

1.2 Liability and warranty

This instruction manual was created considering existing standards. It has to be kept near the system and easily accessible for all staff working on and with the system.

Additionally, all laws, standards and regulations of the country, in which the system is mounted and operated, have to be observed.

The manufacturer does not assume liability or warranty for damages or consequential damages occurring through:

- non-intended use
- non-authorised or non-professional changes of the connections, settings or programming of the system
- non-observance of rules and regulations for safe operation
- Operation of unauthorised or unsuitable devices on the Low Power System

1.3 Copyright protection

All content, drawings, images, and other illustrations are copyrighted.

1.4 Spare parts

Only original spare parts of the manufacturer must be used. Wrong or defective spare parts can lead to damages, malfunctions or total failure of the system. Furthermore, the use of unauthorised spare parts voids all guarantee, warranty, service, compensation, and liability claims.

1.5 Disposal

Packaging materials are no waste but reusable materials which have to be recycled.

Batteries and electronic components contain materials which can lead to damages to health and the environment when inappropriately disposed. National rules and regulations for the appropriate disposal of used batteries and electronic components have to be observed!

2 Safety

The group supply system is safe to operate and complies with valid and recognised rules of engineering at the time of its development and production. There is, however, the risk of danger when the system is used by non-professional staff or when it is used in a non-professional or non-intended way.

The system and the connected parts must only be operated in perfect condition. The following have to be observed:

- safety instructions and hazard notes in the instruction manual
- specified work and safety instructions of the operator

Errors which influence the function or safety of the system have to be reported to the responsible person and cleared immediately.

2.1 Content of the instruction manual

Each person working on or with the system has to read and understand the instruction manual completely prior to any work on the system or battery, even when this person has already worked with this system or a similar one or has been trained by the manufacturer.

2.2 Changes and modifications of the system

Any changes or extensions to the system, which are not authorised by the manufacturer, are prohibited in order to avoid hazards and to guarantee an optimal performance of the system. Extensions, modifications or maintenance works, which are not described in the instruction manual, have to be carried out by trained service personnel only!

2.3 Responsibility of the operator

As described in point 1.2, this instruction manual has to be kept near the system and easily accessible for all staff working on and with the system.

The system must only be operated in technically perfect and operationally reliable condition. Additionally, prior to its commissioning, the system has to be checked for intactness.

2.4 Staff requirements

Only skilled technicians or authorised qualified personnel are permitted to work on or with the system after being briefed about possible hazards.

Staff are considered qualified if they are able to judge the work to be done and recognise possible hazards based on their training, expertise and experiences as well as their knowledge of the respective regulations.

If the staff lacks the necessary knowledge, they need to get a professional instruction. You also have to make sure that the tasks are clearly defined and understood and the works are carried out under supervision of skilled technicians.

2.5 Safety at work

Observance of safety notes and instructions is the basis of safe working and thus damage to persons and property while working on and with the system can be avoided.

The following organisational measures have to be defined in writing and observed:

- safety measures during the work e.g. disconnecting the power supply and securing it against reconnection, standby lighting
- protection and safety devices against hazards from neighbouring parts of the system
- protection and safety devices for personnel working on the system
- obligation to inform and report on beginning, duration and ending of the works

Observe ESD-protection while working on the system!

2.6 Personal protection equipment

Always wear protection gear while working on and with the system:

protective clothing (tight-fitting, low tensile strength, no wide sleeves, no rings or other jewellery)

safety shoes (ESD-shoes according to standard EN 345)

3 Preface

Thank you very much for buying an “multiControl *plus*” power supply system with central battery! This system complies with the standards DIN EN 50171, DIN VDE 0108-100 as well as DIN VDE 0100-718 (versions relevant on delivery) and guarantees the correct functioning of your emergency lighting system by means of a state-of-the-art micro-processor-controlled function control system. This documentation has been created for you to quickly commission and operate the system in an uncomplicated way.

We recommend the following course of action:

1. Observe the relevant danger signs and safety instructions (chapter 4)
2. Make yourself familiar with the design of the MC system (chapter 6)
3. Mount the system and batteries and connect them (chapter 7)
4. Commission the system (chapter 8)
5. Program the system (chapter 9)

Chapter 12 provides a description of the central control unit and a menu – quick reference guide. Instruction for operation and maintenance of the batteries as well as the technical data of the system you can find in chapters 13 and 14. The exact circuit diagram along with other information on your system can be found in the separate document “Information on your multiControl *plus*”.

Note: The table in chapter 14 with the key data of the batteries used in the system has to be completed by the installer.

Note: For maintenance works and modifications the system has to be de-energised by a specialist. The necessary steps are described in chapter 0.

Note: Instructions regarding the programming of the system by means of the WebInterface can be found on the web homepage of the manufacturer.

3.1 Installation location and environmental conditions

The system and the battery system can be operated at an altitude of up to 2000m above standard elevation zero, without any power reduction, and must be placed in an appropriate room satisfying the following environmental condition:

- Air temperature: 10 °C to 35 °C
- Humidity: up to 85% max. (non-condensing, refer to DIN EN 50171)









When selecting the operation room, make sure that sufficient ventilation according to DIN VDE 0510; EN 50272-2 and EitBauVO is assured. Also, please make sure that the room fulfills the conditions corresponding to the protection class of the system (see DIN EN 60529 and 60598).

Note: The power and capacity of the battery system depends on the temperature. The recommended temperature range is 10 °C to 30 °C, the ideal operating temperature is 20 °C ± 5K. Technical data given is valid for a nominal operating temperature of 20 °C.

Note: The system must be located in the building such that the allowed cable lengths allowed for emergency lighting circuits will not be exceeded (see chapter 7.1.14).

4 Danger and information signs

Please strongly obey the safety instructions when installing and using your multiControl *plus* system.

	<ul style="list-style-type: none"> • Observe instructions and keep them located near the battery system for future reference! • Work on the battery system should only be carried out by qualified personnel! • No guaranty in cases of non-observance of instruction manual, repair using non-original parts or unauthorised intervention!
	<ul style="list-style-type: none"> • Do not smoke! Do not use any naked flame or other sources of ignition. There is the danger of explosion and fire hazards!
	<ul style="list-style-type: none"> • While working on batteries wear protective eye-glasses and clothing! • Observe the accident prevention rules as well as DIN VDE 0510, VDE 0105 part 1 (version relevant on delivery)!
	<ul style="list-style-type: none"> • Any acid splashes on the skin or in the eyes must be flushed with plenty of water immediately. Then seek medical assistance. Spillages on clothing should be rinsed out with water!
	<ul style="list-style-type: none"> • Explosion and fire hazard, avoid short circuits! Caution! Metal parts of the battery are always energised; therefore do not place items or tools on the battery!
	<ul style="list-style-type: none"> • Electrolyte is strongly corrosive and acidic. In normal working conditions the contact with electrolyte is nearly impossible; electrolyte may leak from the vent valves in case of overcharging the battery or in case of mechanical damage to the container. In case of any contact with electrolyte please flush with water abundantly and seek medical assistance.
	<p>Batteries / cells are heavy! Ensure adequate mounting security and always use adequate handling equipment for transportation.</p>
	<p>Disposal of batteries Batteries marked with the recycling symbol should be processed via a recognised recycling agency. By agreement, they might be returned to the manufacturer. Batteries must not be mixed with domestic or industrial waste.</p>

5 Scope of delivery

Included in the delivery of the multiControl *plus* system are:

- 1x system multiControl *plus* in floor standing cabinet
- 18x battery (different types possible)
- 1x battery connector cable set
- 1x brief instruction (this document)

Other tools and materials necessary for installation (brought by the installer):

- measuring device for voltage measurements of up to 500VAC or 300VDC
- slotted screw driver width 5.5mm
- hexagon socket wrench SW13 or slotted screw driver 10mm
- Phillips screw driver PZ2
- $\frac{1}{4}$ "-tool with torque variable between 0 and 22Nm

6 System overview

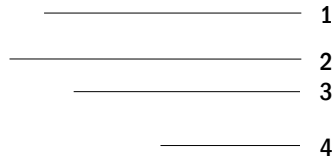

Abbildung

Abbildung

Fig. 1: Front view

Fig. 2: Inside view

- | | | | |
|---|--|----|---|
| 1 | Operation mode switch (BAS)
0 = Charging mode (Luminaires off / no emergency lighting function)
I = Ready-to-operate (emergency lighting function given) | 7 | Ethernet connection |
| 2 | Control centre | 8 | Connection switch contacts |
| 3 | Charger units Type LDM á 2,5A | 9 | Connection for bus-compatible modules |
| 4 | Circuit modules Type DCM | 10 | CCIF critical circuit connection |
| 5 | Fuse switch disconnecter F1 for mains connection | 11 | Battery fuse type depending on size of the fuse |
| 6 | Connection consumer terminals | 12 | Isolating transformers 800VA per LDM |

*similar to illustration

6.1 Overview electronic housing back view



Abbildung

Abbildung

Fig. 3: Back view graphical

Fig. 4: Back view schematic

- 13 Operation mode switch
 - 0 = Charging mode (Luminaires off / no emergency lighting function)
 - 1 = Ready-to-operate (emergency lighting function given)
- 14 Central-Bus
- 15 Bus for DCM modules

*similar to illustration

7 Mounting and installation of the power supply system

7.1 Connection of the charger and switch unit

7.1.1 Mains connection (terminal X01)

Make sure that the mains power line is de-energised and dimensioned according to the maximum connected load. Connect the mains line to the mains terminals (Fig. 2; Number 5) for which you have to remove the mains fuses.

Caution: The mains power line gets energised at a later time (see chapter 8).

System type	L1	L2	L3	type
multiControl <i>plus</i>				

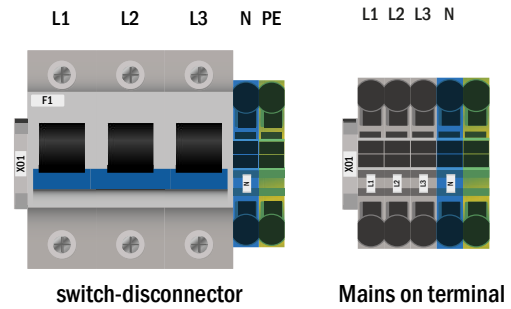

Fig. 5: Mains connection (F1)

7.1.2 Battery fuse

The following table shows the type of the battery fuse (D02 Innozed or NH00) for the systems multiControl *plus* in Ampere. The type is depending on the size of the battery fuse.

System type	B+	SYM	B-	type
multiControl <i>plus</i>				

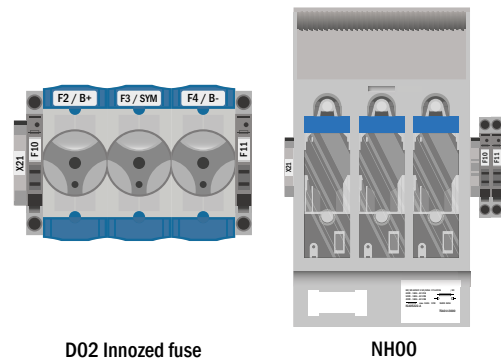

Fig. 6: Battery fuse

7.1.3 Battery connection (terminal X21)

Connect appropriately labelled cables to the three contacts (B+, B- and SYM) of the battery connection as shown in Fig. 7, which are then led to the battery system (see chapter 7.2).

Note: Depending on the mechanical design, these terminals can be omitted.

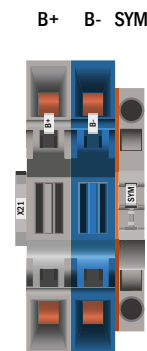

Fig. 7: Battery connection

7.1.4 Outgoing substation – ABUS (terminal X3x)

The ABUS is used for the protected voltage supply of a substation and is mounted in the main unit of a system. The ABUS consists of the terminals for AC supply (L1, L2, L3, N, PE), DC supply (B + / B-) and the start signal (LDM +). The backup dimensioning of the ABUS is stored in the technical data. It is not permissible to disconnect the AC supply of the substation from the local general light distributor! Since the line cross section depends on both the fuse dimensioning and the connection power and the cable length, this must be defined by the installer.

A port or terminals for networking are not provided for the ABUS; networking is done via the internal port or switch (X10).

The network is networked and is used to monitor the substation (s) through the main unit.

Note: If there are several outgoing, please refer to the attached circuit diagram documents for the fuses from the fuse list.

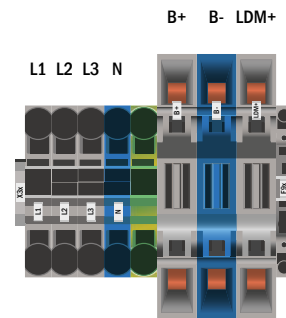

Fig. 8: Outgoing substation - ABUS

7.1.5 Outgoing sub-distributor - ABUV (terminal X4x)

The ABUV is used for the protected voltage supply and data transmission of a multiControl plus sub-distributor (MC-UV) and is mounted in the main unit of a system assembly. The ABUV consists of the terminals for AC supply (L1, L2, L3, N, PE), DC supply (B + / B-) and the terminals for the data line. The fuse dimensioning of the ABUV is stored in the technical data. The AC supply of the MC-UV on the local general light distributor is not permitted! Since the line cross section depends on both the fuse dimensioning and the connection power and the cable length, this must be defined by the installer.

Note: If there are several outgoing, please refer to the attached circuit diagram documents for the fuses from the fuse list.

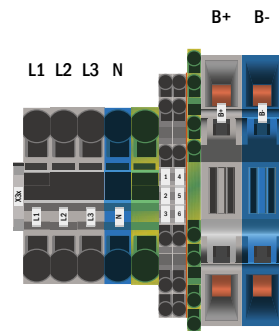

Fig. 9: Outgoing sub-distributor - ABUV

7.1.6 Outgoing sub-distributor – single wire supply – ABUV-E (terminal X4x)

The ABUV-E is used for the protected voltage supply and data transmission of a multiControl plus sub-distributor (MCUV-E) and is mounted in the main unit of a system assembly. The ABUV-E consists of the terminals for AC/DC supply (l/+ / N/-) and the terminals for the data line. For the power supply of the MCVU-E, only a 3-wire cable is required in this system. The fuse dimensioning of the ABUV-E can you find in the technical data. Because the cable cross-section depends on the fuse dimensioning, as well as on the connected load and cable length, this must be determined by the installer.

Note: If there are several outgoing, please refer to the attached circuit diagram documents for the fuses from the fuse list.

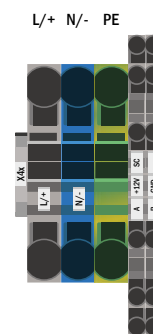

Fig. 10: Outgoing sub-distributor single wire supply – ABUV-E

7.1.7 SAM24 switching inputs (terminal X03)

In connection with the switch interrogation module, circuits or luminaires can be switched. Optional and depending on the device configuration, the SAM24 can be installed in the multiControl *plus* system.

For the connection of the 8 electrically isolated switching inputs E1-E8, a corresponding number of three-pole terminals are available to which the switching voltage (220 / 230V 50 / 60Hz, 24-255V DC) is to be connected. A switching voltage of 24V DC is provided at an additional terminal.

Optionally, the integrated 3-phase mains monitor as well as the COM port2 can be provided on terminals.

Detailed information on the SAM24 can be found in the corresponding product information.

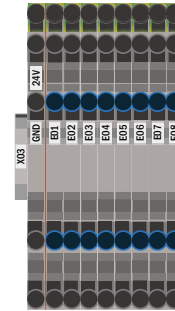

Fig. 11: SAM24 switching inputs

7.1.8 Ethernet interface (terminal X10)

The multiControl *plus* system has an Ethernet interface by means of which it can be embedded in a network for remote monitoring. Fig. 12 shows the network connection inside the cabinet. Please use standard network cable (Cat. 5 / RJ45) for connection.

The simple adapter is installed as standard. Optionally, the installation of a switch is possible (in conjunction with Panel-PC, GLT or networking of systems)

The network connections of the multiControl *plus* have the following characteristics:

- 10Mbps
- Half-duplex

These parameters must be supported by the network infrastructure.

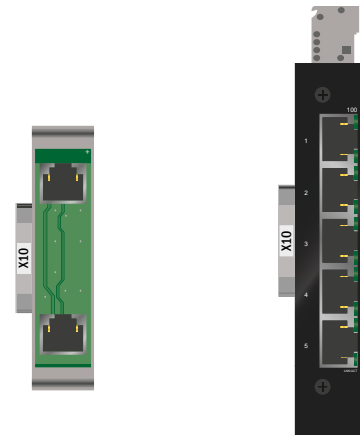

Fig. 12: Ethernet connection

7.1.9 Switch contacts (terminal block X02)

voltage supply:

F5 GND (positive potential)
 F6 -24V DC (negative potential)

de-energised contacts:

contact 1/2 closed: malfunction
 contact 2/3 closed: system works properly
 contact 4/5 closed: battery operation
 contact 5/6 closed: mains operation
 contact 7/8 closed: ready to operate
 contact 8/9 closed: charging mode
 contact 16/17 closed^{[1][3]}: fan control de-energised (LUAN1)

energised contacts:

contact 10/11^[1]: battery cabinet temperature sensor
 contact 14/15 closed: system in charging mode
 contact 16/17 closed^[1]: fan control single-phase (LUAN2)
 contact 30/31 closed: configurable

contact L1/L2/L3/N^[1]: fan control three-phase (LUAN3)

^[1] optional

^[2] Switching contacts energised (24V DC)

Attantion: Applying an external voltage will destroy the IO-module.

^[3] Fan control active: while fast charge + 10min follow up time

Maximum switching current K1-K7: 6A / 250 AC1; 6A / 30V DC

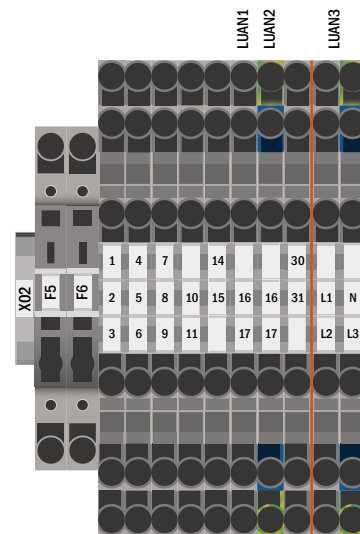

Fig. 13: Switch contacts

7.1.10 2nd error messages (terminal X18) (optional)

de-energised contacts:

contact 1/2 closed:	malfunction
contact 2/3 closed:	system works properly
contact 4/5 closed:	battery operation
contact 5/6 closed:	mains operation
contact 7/8 closed:	ready to operate
contact 8/9 closed:	charging mode

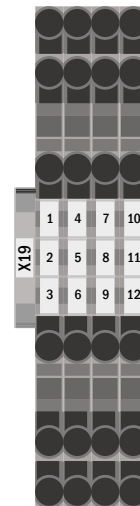

Fig. 14: 2nd error messages

7.1.11 Error messages 2nd IO-module (terminal X19) (optional)

de-energised contacts:

contact 1/2 closed:	circuit failure
contact 2/3 closed:	circuit OK
contact 4/5 closed:	test mode
contact 5/6 closed:	no test mode (ready to operate)
contact 7/8 closed:	luminaire fault
contact 8/9 closed:	luminaires OK
contact 10/11 closed*:	symmetry OK
contact 11/12 closed*:	symmetry fault



*Depending on the software version, this message is negated.

Fig. 15: error messages 2nd IO-module

7.1.12 Critical circuit (terminal block X22 F7/F8, optional CCIF)

The critical circuit is used to monitor a residual current / mains monitor loop about PC230 line monitors. When a mains monitor is triggered, emergency operation (mod. management [AC]) is triggered in the entire system.

F7 / F8: The system registers an interruption of the network monitoring loop and triggers emergency operation in the system. The voltage on the line monitor loop is 15V AC. Since a lump is not registered, fire-resistant cable material is necessary.

CCIF: The CCIF is available as an option and registers both the interruption of the network monitoring loop and the clumping (termination on the line) and triggers emergency operation in the system. The voltage on the line monitor loop is 24V DC. Fire-resistant cable material is not necessary. Please note the product information.

Applying voltage to these terminals is not permitted and will destroy the system!

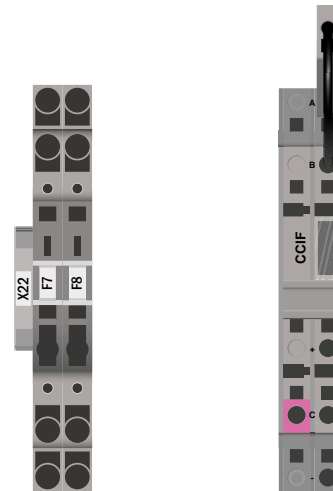

Fig. 16: critical circuit

7.1.13 Bus-compatible modules (terminal block X07)

Terminal block X07 serves as a connection to external, bus-compatible command and switch modules. Please use a screened 4-core bus cable (e.g. J-Y(St)-Y). The following modules can be connected:

- SAM24
- MC-LM
- MCT

For further informations see chapter 16 – „module descriptions“.

The use of NYM lines or similar is not permitted!

Note: During all installation work on the RS485 bus (add / remove modules and address changes), the device must be switched completely free of voltage.

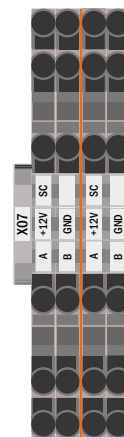

Fig. 17: Connection bus-compatible modules

7.1.14 Output circuits (terminal block X30)

Fig. 18 shows the terminal block X30 to which the consumer circuits (luminaires) can be connected. Pay attention to the correct polarity and use mains-compatible cables; comply with the standards MLAR, EItBauVo as well as DIN VDE 0100.

Note: The circuits to be connected have to be checked for installation errors such as short circuit and earth fault prior to connection.

Note: L = Phase; N = neutral conductor

Note: Maximum cable length of 500m and maximum 20 luminaires per final circuit.

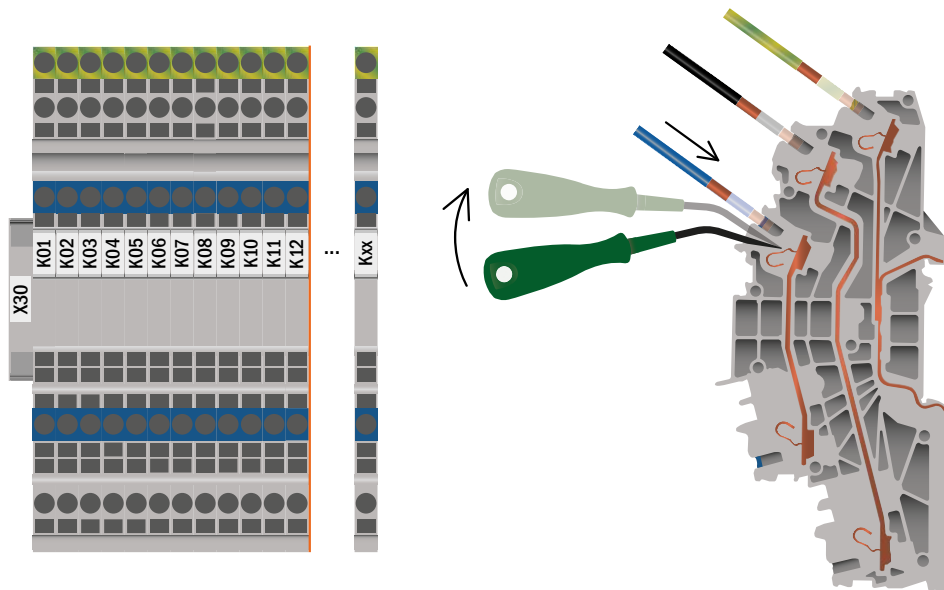

Fig. 18: Connection electric - Terminal X30

Central Power Supply System multiControl plus

7.2 Mounting and installation of the battery system

7.2.1 Mounting

Mount the battery rack and position it at the designated place. When choosing the battery room, pay attention to sufficient ventilation according to DIN VDE 0510; EN 50272-2 and EltBauVO (versions relevant on delivery). Now place the battery blocks on the respective level in the battery rack. The temperature difference between the individual battery blocks must not exceed 3 °C.

Note: Before commissioning all blocks have to be checked for mechanical damage, correct polarity and that the cables are firmly connected.

OGV	Battery dimension (length, width, height) in mm	Battery connector			Battery cabinet							
		Pol	Connector in mm ² /flexible	Order of the poles	Combi 1000 (1 shelf)	Combi 1500 (2 shelves)	BATT9 (2 shelves)	BATT11 (2 shelves)	BATT18 (5 shelves)	BATT20 (5 shelves)	MCX with BATT-Cabinet (2 shelves)	
5,2	90*70*107	6,3 mm	2,5		RV2.5: 16*300mm EVL2.5: 1*1000mm	RV2.5: 15*300mm EV2.5: 2*1000mm	RV2.5: 15*300mm EVL2.5: 2*1000mm	RV2.5: 15*300mm EVL2.5: 2*1000mm	X	X	RV2.5: 15*300mm EVL2.5: 2*1000mm	
7,2	151*65*100	6,3 mm	2,5		RV2.5: 16*300mm EVL2.5: 1*1000mm	RV2.5: 15*300mm EV2.5: 2*1000mm	RV2.5: 15*300mm EVL2.5: 2*1000mm	RV2.5: 15*300mm EVL2.5: 2*1000mm	X	X	RV2.5: 15*300mm EVL2.5: 2*1000mm	
12	151*98*95	6,3 mm	2,5		RV2.5: 16*300mm EVL2.5: 1*1000mm	RV2.5: 15*300mm EV2.5: 2*1000mm	RV2.5: 15*300mm EVL2.5: 2*1000mm	RV2.5: 15*300mm EVL2.5: 2*1000mm	X	X	RV2.5: 15*300mm EVL2.5: 2*1000mm	
17	181*77*167	M5	6		RV16S: 16*350mm EVL16S: 1*1000mm	RV16S: 15*350mm EVL16S: 2*1000mm	RV16S: 15*350mm EVL16S: 2*1000mm	RV16S: 15*350mm EVL16S: 2*1000mm	X	X	RV16S: 15*350mm EVL16S: 2*1000mm	
26	165*176*127	M5	6		X	RV16S: 15*350mm EVL16S: 2*1000mm	RV16S: 15*350mm EVL16S: 2*1000mm	RV16S: 15*350mm EVL16S: 2*1000mm	X	X	RV16S: 15*350mm EVL16S: 2*1000mm	
28	165*125*175	M5	6		X	RV16S: 15*350mm EVL16S: 2*1000mm	RV16S: 15*350mm EVL16S: 2*1000mm	RV16S: 15*350mm EVL16S: 2*1000mm	X	X	RV16S: 15*350mm EVL16S: 2*1000mm	
33	195*130*155	M6	16		X	RV166: 15*350mm EVL166: 2*1000mm	RV166: 15*350mm EVL166: 2*1000mm	RV166: 15*350mm EVL166: 2*1000mm	X	X	RV166: 15*350mm EVL166: 2*1000mm	
40	197*165*170	M6	16		X	RV166: 15*350mm EVL166: 2*1000mm	RV166: 15*350mm EVL166: 2*1000mm	RV166: 15*350mm EVL166: 2*1000mm	RV166: 12*350mm EVL166: 5*1000mm	X	RV166: 15*350mm EVL166: 2*1000mm	
45	197*165*170	M6	16		X	RV166: 15*350mm EVL166: 2*1000mm	RV166: 15*350mm EVL166: 2*1000mm	RV166: 15*350mm EVL166: 2*1000mm	X	X	RV166: 15*350mm EVL166: 2*1000mm	
50	257*132*200	M6	16		X	X	RV166: 15*350mm EVL166: 2*1000mm	RV166: 15*350mm EVL166: 2*1000mm	RV166: 12*350mm EVL166: 5*1000mm	RV166: 12*350mm EVL166: 5*1000mm	RV166: 15*350mm EVL166: 2*1000mm	
55	229*138*208	M6	16		X	RV166: 15*350mm EVL166: 2*1000mm	RV166: 15*350mm EVL166: 2*1000mm	RV166: 15*350mm EVL166: 2*1000mm	RV166: 12*350mm EVL166: 5*1000mm	RV166: 12*350mm EVL166: 5*1000mm	RV166: 15*350mm EVL166: 2*1000mm	
60	260*168*211	M6	16		X	X	X	X	RV166: 12*350mm EVL166: 5*1000mm	RV166: 12*350mm EVL166: 5*1000mm	RV166: 15*350mm EVL166: 2*1000mm	
65	350*167*179	M6	16		X	X	X	X	RV166: 12*350mm EVL166: 5*1000mm	RV166: 12*350mm EVL166: 5*1000mm	RV166: 15*350mm EVL166: 2*1000mm	
75	260*168*211	M6	16		X	X	X	X	RV166: 12*350mm EVL166: 5*1000mm	RV166: 12*350mm EVL166: 5*1000mm	RV166: 15*350mm EVL166: 2*1000mm	
80	260*168*211	M6	16		X	X	X	X	RV26S: 12*450mm EVL26S: 5*1000mm	RV26S: 12*450mm EVL26S: 5*1000mm	RV26S: 15*450mm EVL26S: 2*1000mm	
90	306*169*211	M6	16			X	X	X	X	RV26S: 12*450mm EVL26S: 5*1000mm	RV26S: 12*450mm EVL26S: 5*1000mm	RV26S: 15*450mm EVL26S: 2*1000mm
100	330*171*214	M8	25			X	X	X	X	RV26S: 12*450mm EVL26S: 5*1000mm	RV26S: 12*450mm EVL26S: 5*1000mm	RV26S: 15*450mm EVL26S: 2*1000mm
110	330*171*214	M8	25			X	X	X	X	RV26S: 12*450mm EVL26S: 5*1000mm	RV26S: 12*450mm EVL26S: 5*1000mm	RV26S: 15*450mm EVL26S: 2*1000mm
120	409*176*225	M8	25			X	X	3*BATT9 K2S: 1*3000mm RV25S: 9*450mm EVL25S: 7*1000mm	X	2*BATT18 K2S: 1*3000mm RV25S: 12*450mm EVL25S: 4*1500mm	RV25S: 12*450mm EVL25S: 5*1000mm	X
134	342*172*280	M8	25	X		X	X	X	2*BATT18 K3S: 1*3000mm RV35S: 12*450mm EVL35S: 4*1500mm	RV35S: 12*450mm EVL35S: 5*1000mm	X	
150	485*172*240	M8	35	X		X	3*BATT9 K3S: 1*3000mm RV35S: 9*450mm EVL: 7*1000mm	X	2*BATT18 K3S: 1*3000mm RV35S: 6*450mm EVL35S: 10*1000mm	RV35S: 12*450mm EVL35S: 5*1000mm	X	
180	530*172*240	M8	35	X		X	X	X	3*BATT18 K3S: 2*3000mm EVL35S: 15*1000mm	RV35S: 12*450mm EVL35S: 5*1000mm	X	
200	522*238*218	M8	25			X	X	X	X	3*BATT18 K3S: 2*3000mm EVL35S: 15*1000mm	RV35S: 12*450mm EVL35S: 5*1000mm	X
260	521*269*220	M8	25			X	X	X	X	3*BATT18 K50: 2*3000mm EVL50S: 15*1000mm	2*BAT20 K50: 1*3000mm RV50S: 6*450mm EVL50S: 10*1000mm	X

7.2.2 Battery connection

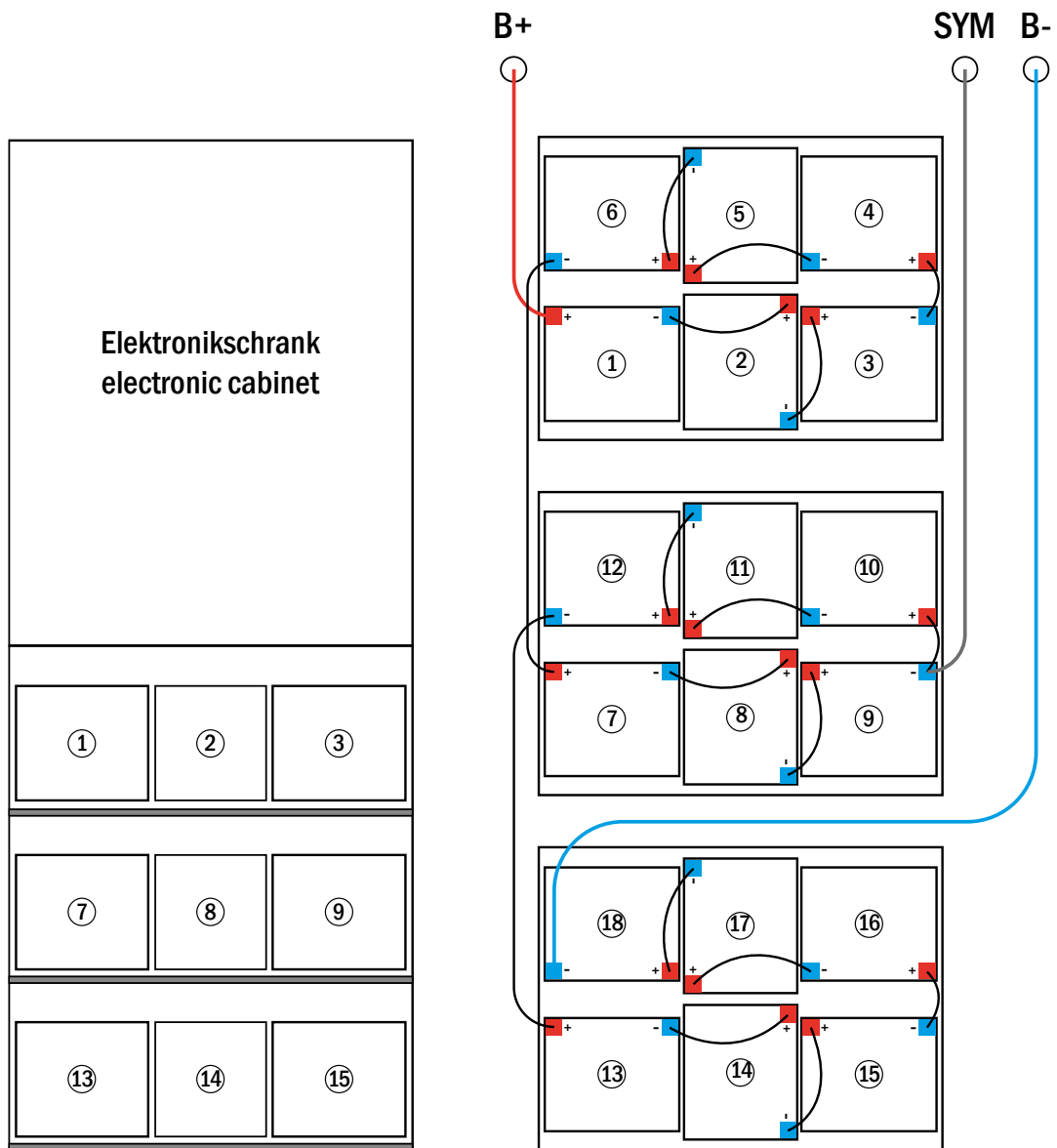

Fig. 19: Battery connection

Capacities (Kn) at different discharge times (Tn), up to the given cut-off voltage (US) at battery temperature of 20°C:

Typ OGiV	Tn	10 min.	30 min.	1h	3h	5h	10h	20h
	Kn=C1/6 (Ah) US=1.80V/C	Kn=C1/2 (Ah) US=1.80V/C	Kn=C1 (Ah) US=1.80V/C	Kn=C3 (Ah) US=1.80V/C	Kn=C5 (Ah) US=1.80V/C	Kn=C10 (Ah) US=1.80V/C	Kn=C20 (Ah) US=1.80V/C	
OGiV 12170	6.5	8.7	9.9	12.2	139	15.6	17.0	
OGiV 12260	10.8	13.6	15.0	19.7	21.4	23.7	25.0	
OGiV 12280	11.2	14.8	16.6	20.2	22.9	25.8	28.0	
OGiV 12330	11.8	16.3	19.0	24.8	28.9	33.0	33.6	
OGiV 12400	13.5	19.2	23.7	30.0	35.3	40.0	41.0	
OGiV 12450	14.7	20.7	24.6	32.4	37.8	44.0	45.0	
OGiV 12550	21.7	29.8	32.8	42.6	48.5	55.0	57.0	
OGiV 12600	21.0	30.0	34.5	45.0	53.0	60.0	63.0	
OGiV 12650	23.8	32.2	37.4	48.6	56.5	65.0	68.0	
OGiV 12750	26.3	37.5	43.1	56.1	66.0	75.0	78.8	
OGiV 12800	29.2	40.3	47.4	58.8	70.5	80.0	84.0	
OGiV 12900	31.5	45.0	51.7	67.5	79.5	90.0	94.6	
OGiV 121000	36.7	52.0	59.3	76.5	89.0	100.0	106.0	
OGiV 121100	38.5	55.0	63.2	82.5	97.0	110.0	115.6	
OGiV 121200	41.7	62.5	71.2	89.7	106.0	120.0	124.0	
OGiV 121340	48.3	69.0	79.3	98.4	118.5	134.0	140.0	
OGiV 121500	55.0	77.0	88.9	114.6	133.5	150.0	156.0	
OGiV 122000	71.7	101.0	119.0	157.2	181.5	200.0	204.0	
OGiV 122600	87.5	127.0	149.0	185.1	220.5	250.0	264.0	

7.2.3 Connection of the battery blocks

Disconnect the battery fuses by opening F2 and F4. Connect the battery blocks in series as shown in Fig. 19. Afterwards connect the cables coming from F2 (Fig. 2, Number 12) as illustrated Fig. 19 (red = B+/positive pole to the positive pole of block 1, grey = symmetry to the negative pole of block 9 and blue = B-/negative pole to the negative pole of block 18). If necessary, put on the pole covers.

After correct connection of the cables the following measurements should be carried out:

Voltage between F2 and F4: until about 240V DC

Voltage between F2 and F3: until about 120V DC

Voltage between F3 and F4: until about 120V DC

Note: Observe polarity. A beep signalises wrong polarity.

The following torques apply to the screw joints:

Thread Diameter	Maximum Torque
M5	2 - 3Nm
M6	4 - 5,5Nm
M8	5 - 6Nm
M10	14 - 22Nm

8 Commissioning of the power supply system

Open the housing for commissioning the system. Fig. 2 schematically shows the view of an open system cabinet. Continue as follows (the numbers in brackets refer to Fig. 1 and Fig. 2):

- 1. Operation mode switch to charging mode.** Turn the operation mode switch (Fig. 1, Number 1) to charging mode (position „0“).
- 2. Connect battery fuses.** Connect the battery fuses (Fig. 2, Number 12) again by closing F2.
- 3. Supply mains power.** Supply mains power and check the power terminals for correct configuration by conducting the below-listed measurements. In case of a misconfiguration (connection error) abort commissioning:

voltage between L1 and N	}	These voltages should range from ca. 220V to 240V (supplied mains power). If they do not, this indicates a connection error.
voltage between L2 and N		
voltage between L3 and N		
voltage between L1 and PE		
voltage between L2 and PE		
voltage between L3 and PE		
voltage between PE and N		

This voltage should be zero. If it is not, this indicates a connection error.

- 4. Connect mains fuses.** Connect the mains fuses (Fig. 2, Number 5) by closing F1. The system is now activated.
- 5. Await the end of the boot process.** After switching on the system (acoustic signal) it starts booting. This process can last several minutes. During and after the boot process the LC-Display should show the following (see Fig. 20):

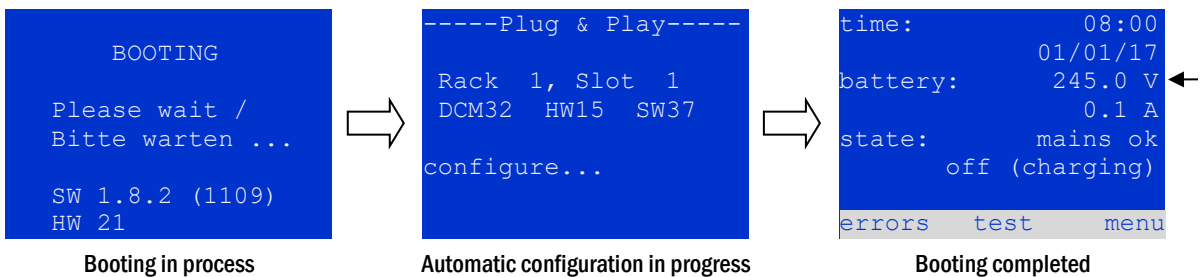

Fig. 20: Booting routine (left, middle) and status (right).

- 6. Check battery voltage.** Check the battery voltage by means of the status information in the LC-Display. It should range from 192V to 250V (Fig. 20, right picture, arrow).
- 7. Operation mode switch to “ready-to-operate”.** Turn the operation mode switch (1) to “ready-to-operate” (position “1”). This activates the electric circuits (by default maintained lighting).



Caution: Make sure that nobody works on the electric circuits before switching the system on as circuits in maintained lighting mode get energised when activated. If there are still circuits that are worked on, remove the respective fuses before switching on the system.

- 8. Check voltage at circuit outputs.** By default all end circuits are configured as maintained lighting mode. Check the voltage on all circuit connection terminals (7) (see also chapter 7.1.14, Fig. 18). The measured voltage on each circuit and connection in maintained lighting should correspond to the mains voltage.
- 9. Check the battery for sufficient capacity.** During battery discharge, the system must be operated with the actual load for the specified time. A manual capacity test is recommended (see 10.3). The results are to be logged. Systems which do not pass this test must be repeat the test. If the repeat test is not sufficient, the system must not be put into operation (see measuring protocol battery).

9 Setting up your system

9.1 General operating instructions

Your system can be operated and configured completely via the front control elements (Fig. 21). For text input (e.g. circuit denomination) we recommend connecting an external keyboard to the PS2-interface (1).

The LCD-screen (2) displays Menues and Informationen. In the bottom line you can see - if active - the **softkey functions** which are reachable via the 3 softkeys (3) (Fig. 22). For navigation and data input please use the arrow keys <, >, ^ and v (4) as well as the enter key ○ (5). The up ^ and down v keys are mostly used for selecting menus and input fields. A selected menu item is indicated by **inverted colouring**. The right > and left < keys are used to change values; in some cases you have to confirm your input with the enter key ○. An arrowhead > on the right indicates a submenu which can be selected with the right > or enter ○ key. You can return from there using the softkey **back** or **done**.

The following paragraphs give some basic instructions for configuring your system. The LCD-screen shows the necessary functions which can be navigated to and then selected. The line under the headline of each paragraph describes how to get to the required menu item:

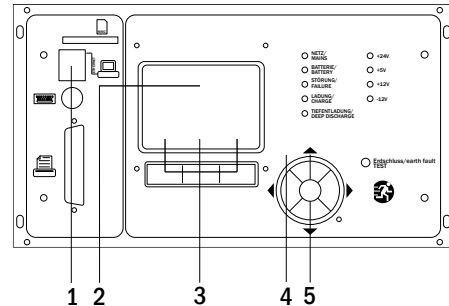

Fig. 21: Control elements

9.2 System state

After commissioning the LC-display shows the state of the system (Fig. 22) i.e. time (1) and date (2), current battery voltage (3) and battery charging current (in battery operation – discharging current) (4), system state (5, 6). Via the soft-keys (8) you can select the `help`-function, conduct a `test` or reach the `menu`.

Note: The system returns from each display to the status after ca. two minutes if no input is made.

```
time:           08:00  -1
                01.01.17 -2
battery:        245.0 V -3
                0.0 A   -4
state:          mains ok -5
                off (charging) -6
                -7
                test  menu -8
```

Fig. 22: System state

Display-lines 5, 6 and 7 show the following status messages:

Status	Explanation
Zelle 5	
mains ok	mains connected and OK
mains failure	mains voltage failed
Zelle 6	
(off) charging	luminaires switched off, emergency operation blocked, battery is being charged
operational	maintained lighting luminaires (DS) switched on, emergency operation possible
off	mains failure, but no emergency operation possible
active (battery)	mains failure, emergency operation active
active (mains)	all luminaires with mains connection on
line 7 (if required, additional messages possible)	
critical circuit	break of quiescent current loop
SAM 1 E 1 or similar	modified non-maintained lighting activated by SAM or MC-LM (text configurable)
RS485 fault	failure of RS485 bus interface
earth fault	earth fault in mains operation
earth fault (B)	earth fault in battery operation
maintenance required	carry out maintenance (service)
deep discharge 1	battery deeply discharged
charger fault	charger module failed/fuse activated
Plug & Play error	wrong component used
DCM fault	DCM failed
ACM fault	ACM failed
IOM fault	IO-Modul failed
battery fuse	battery fuse defect
battery voltage	battery voltage out of tolerance
battery current	battery current out of tolerance
battery discharge	battery is being discharged in mains operation
luminaire fault	luminaire failure after testing
luminaire current fault	total current value out of set tolerance
circuit fault	error in electric circuit (fuse activated etc.)
sub-station fault	(communication) failure of sub-station
sub-station mb	sub-station in modified non-maintained operation
sub-station mains fail	mains failure of sub-station
fan failure	fan failed
batt. temp. sensor	temperature sensor inserted
internal fan	failure internal fan
external fan	failure external fan
UV-C failure	failure of sub-distributor
UV-C mains failure	mains failure of sub-distributor
battery symmetry	battery symmetry unbalanced
IOM fault	IOM module fault
test locked	test blocked by boost charge, battery voltage or emergency operation
system temperature	system temperature >55°C
circuits unpowered	end circuits and test locked
L1/L2/L3/N failure	voltage on neutral conductor
test aborted	Function-/ capacity test is aborted (mains failure, ...)

9.3 Selecting circuits and checking their state

State → INFO-pushbutton DCM → △▽(select circuit)

The electric circuits are numbered beginning with 1; each DCM-module has two circuits named A and B. The circuits are numbered according to their slot position from left to right, so that the A-circuits have an uneven and the B-circuits an even number Fig. 23. If a slot is not used, the respective circuit numbers do not exist either. This means you can add circuits to the system without changing the numbers of existing circuits.

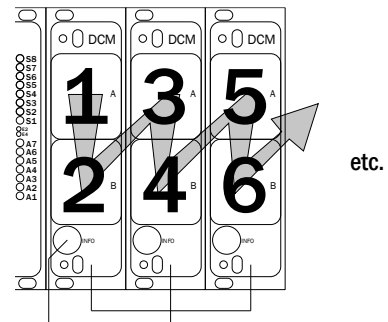

INFO-pushbutton DCM-modules

Fig. 23: Numbering of the circuits

State → INFO-pushbutton (DCM) → △▽(select circuit) → enter ○

Note: The arrow keys △, ▽, ◀ and ▶ (4) and the enter key ○ (5) on the control unit correspond to the arrow and enter keys of an external keyboard. The softkeys (3) correspond to the function keys F1, F2 and F3.

After pressing the INFO-pushbutton on the DCM-module (Fig. 23), the display shows the status of the respective circuits. Now the display shows the following information for circuits A and B (Fig. 24):

- 1 - circuit number
- 2 - current output (in brackets: reference value for the circuit monitoring)
- 3 - status of the circuit

```

----- DCM 42 -----
A: circuit      1 >
  P =    0W (  0W) — 1
  ok — 2
B: circuit      2 >
  P =    0W (  0W) — 1
  ok — 2
test back — 3
    
```

Fig. 24: Circuit state

The number of the selected circuit is marked by inverted colouring (Fig. 24 for circuit A with number 1). With the up △ and down ▽ keys you can change between circuits A and B. Repeated pressing of these keys takes you to the circuit status display of the other modules. Pressing ▶ or Enter ○ takes you to the setup of the selected circuit (see next paragraph). For each circuit the following status messages can be displayed in line 3 (Fig. 24):

State	Explanation	Measure
OK	The circuits works correctly.	-
fuse defect	The circuit fuse in the DCM is defect.	change fuse
current failure	The current is out of the set tolerance.	check luminaires and tolerance
earth fault(B)	Short circuit to earth.	find and correct
overload	Measured current is too high.	keep values within tolerance
not existing	The circuit does not exist (empty slot or circuit B does not exist).	none
error	Other failures.	select module again

9.4 Viewing and changing of the circuit setup

State → INFO-pushbutton DCM → △▽(select circuit) → Enter ○

After pressing the INFO-pushbutton and selecting the required circuit with △ and ▽ (see previous chapter), you reach the setup for this circuit by pressing ▷ or Enter ○ (Fig. 25). The following information is displayed:

- 1 – number of circuit (Fig. 25, Number 1). If this is selected (i.e. invertedly coloured), you can change to the other circuits with ◀ and ▶.
- 2 – stop delay time ^[2] (explanation see below) (Fig. 25, Number 2). It can be set in steps between 1 min and 15 min using ◀ and ▶; alternatively, you can select a manual ^[3] switch-back.
- 3 – operation mode (Fig. 25, Number 3). With ◀ and ▶ you can select the following operation modes:

Operation mode	status when system is ready to operate
maintained lighting	Luminaires are on.
non-maintained lighting	Luminaires are off but get switched on when mains or sub-distributions fail.
deactivated	Luminaires are off (also when mains or sub-distributions fail, i.e. no emergency operation!).

- 4 – monitoring mode (sub-menu) (Fig. 25, Number 4). You can reach the setup screen for the monitoring mode with ▷ or Enter ○ (see next chapter 9.4.1).
 - 5 – name (two lines) (Fig. 25, Number 5). You have 42 digits for naming each circuit. After selecting a line you can change to edit mode by pressing Enter ○. With ◀ and ▶ you choose the position to be changed; the character can be chosen with △ and ▽ (available characters see Fig. 26). You finish the input by pressing Enter ○ or done.
- Tip: Use an external keyboard for entering the names.

^[2] **stop delay:** When switching back from “modified non-maintained lighting” (failure of mains monitor) to “ready to operate”, all luminaires remain on for the programmed stop delay time. When switching back from battery operation, all luminaires keep being supplied with battery voltage for another minute; afterwards the programmed stop delay time starts running. After this time has elapsed, the circuits are switched back to their programmed operation mode (Fig. 25, Number 3).

^[3] **manual:** Turn the operation mode switch briefly to “charging mode” (0) and then back to “ready to operate” (I) for switching back from battery operation.

```

----- modules-----
circuit (DCM42)      1  -1
stop delay:         15min -2
maintained mode     -3
monitoring (L)      >  -4
main building,      -5
ground floor       -┘
help   next   done
    
```

Fig. 25: Circuit state

```

!"#$%&'()*+,-./01234
56789:;<=>?@ABCDEFGHI
JKLMNOPQRSTUVWXYZ[\]^
`abcdefghijklmnopqrs
tuvwxyz{|}
    
```

Fig. 26: Survey of all available characters

9.4.1 Setting the circuit monitoring mode

State → INFO-pushbutton DCM → △▽(select circuit) → Enter ○ → △▽ monitoring → Enter ○

The monitoring setup screen (Fig. 27) shows the number of the circuit in the top line (Fig. 27, Number 1). Using the keys △ and ▽ you can reach the following setup options:

- 1 – highest address of luminaires with single luminaire monitoring existing in the circuit, settable from 01 to 20. This number mostly corresponds with the number of luminaires existing in this circuit. The setting 00 deactivates the single luminaire monitoring.
- 2 – tolerance for the current monitoring. Possible settings: off (no current monitoring), 5%, 10%, 20% (recommended), 50% (Fig. 27, Number 2).
- 3 – measuring of the reference current (Fig. 27, Number 3). You start the measuring by pressing ▷ or Enter ○ and the measured value is saved as a reference for the current monitoring.

```

----- circuit 1 -----
lamp monitoring
lamp count: 00 -1

circuit monitoring
current window: off -2
measure reference > -3
help back
    
```

Fig. 27: Setting of the circuit monitoring

9.4.2 Programming the SAM-module

State → INFO-pushbutton DCM → △▽(select circuit) → Enter → next → SAM programming > → Enter

Pushing the softkey next/F2 takes you to the menu for programming the SAM and the supply time (battery operation) (Fig. 28). If you select the line supply: using the keys △ or ▽ (Fig. 28, Number 2) you can set the supply time for the respective circuit in steps from 3 minutes (3min) to 8 hours (8h 0min) or unlimited (unlimited). Selecting SAM programming > (Fig. 28, Number 1) using ▷ or Enter ○ takes you to the table shown in Fig. 29. For navigating within the table use △, ▽ or Enter ○. In each line you can change the following settings using ◀ or ▶:

- left column: selection of SAM/MC-LM (number 01 to 16),
- middle column: selection of SAM-input (E1...E8, MC-LM, TLS1, TLS2),
- right column: selection of the operation mode (ds, mb, gmb), see table below.

The softkey back/F3 takes you back to the previous display (Fig. 28). Now push the softkeys done/F3 and back/F3 in order to leave the programming. A confirmation prompt appears (Fig. 30). Here you can save the changes with yes or cancel with no. After that you are in the circuit selection menu again.

```

----- circuit 1 -----
SAM programming > -1

supply: unlimited -2

help back
    
```

Fig. 28: SAM-programming

```

--- SAM-circuit 1 ---
01 | E1 | ds
01 | E2 | mb
01 | E3 | gmb
02 | MC-LM |
01 | TLS 1 |
01 | TLS 2 |
help back
    
```

Fig. 29: SAM-programming

```

-----modules-----

save
changes?

yes no
    
```

Fig. 30: SAM-programming

SAM-operation mode	Explanation
ds (maintained lighting)	When a voltage is applied to the input, the luminaires in maintained lighting mode get switched on, the luminaires in non-maintained lighting mode remain off.
mb (modified non-maintained lighting)	In case of a voltage failure on the input all luminaires in non-maintained and switched maintained lighting mode get switched on and the system shows modified non-maintained lighting, see chapter 7.2). In this state the test function is blocked. Upon return of the voltage the system switches back to regular operation after the set stop delay time.
gmb (switched modified non-maintained lighting)	The luminaires in non-maintained and switched maintained lighting mode get switched on when a voltage is applied to the input. In the event of a voltage failure the system switches back to regular operation immediately.

10 Tests

10.1 Execution of a function test

State → test/F2

When the display shows the system state (see chapter 9.2), press `test`/F2 in order to start a function test. If the softkey `test` is not shown there, this indicates a mains failure or that the system is running in modified non-maintained lighting mode. The test function is blocked then. If you hear an acoustic signal on pushing `test`/F2, the test function is blocked by boost charge or a battery voltage below 230V. If there is no signal tone, a so-called manual test is carried out.

The LC-display shows the tested circuits (Fig. 31, Number 1). These circuits are “prepared” prior to the test, i.e. they are switched on with mains voltage and brought to working temperature for an exact current measurement (Fig. 31, Number 2). The duration of this process can be set between 0 and 30 minutes. The progress is indicated by a line of dots behind the words “please wait” (Fig. 31, Number 3).

The test can be cancelled at any time using the softkey `cancel`/F3 (Fig. 31 to Fig. 32, Number 4).

At the beginning of the actual test the display shows the message “under test” (Fig. 32, Number 2). A detected error is shown in line 3 (Fig. 33 Number 3).

After finishing the test the display shows a summary for a few seconds (Fig. 34). and the message “test finished” (Fig. 34, Number 2). Afterwards the display returns to showing the system state. The test results are saved in the log which can be selected and read (see chapter 10.3).

```
-----manual test-----
circuits: 001 - 007      -1
preparing test          -2
please wait ...         -3
cancel                  -4
```

Fig. 31: Test programming

```
-----manual test-----
circuits: 001 - 007      -1
preparing test          -2
please wait .....      -3
cancel                  -4
```

Fig. 32: Luminaire test

```
-----manual test-----
circuits: 001 - 007      -1
preparing test          -2
circuit error           -3
cancel                  -4
```

Fig. 33: Failure detection

```
-----manual test-----
circuits: 001 - 007      -1
test finished           -2
circuit error           -3
cancel                  -4
```

Fig. 34: Testing and fault evaluation

10.2 Programming automatic function tests

State → menu/F3 → configuration → Enter ○△▽ → function test → Enter ○

In the state display press menu/F3 and navigate with △ and ▽ to configuration, press ▷ or Enter ○, and navigate with △ and ▽ to function test. Then press ▷ or Enter ○ again. Now you are in the function test (shown in Fig. 35). Here you can:

- 1 - set the schedule for automatic test,
- 2 - edit the current monitor window during the test,
- 3 - configure the preheat function,
- 4 - see when the next automatic test scheduled.

You finish the test programming with the softkey done/F3. Then the confirmation prompt save changes? appears. If you confirm with yes/F1, the new settings are saved.

```

----function test----
schedule > -1
current monitor > -2
preheat off -3

next schedule: -4
help done
    
```

Fig. 35: Test programming

10.2.1 Setting the schedule

function test → △▽ schedule → Enter ○

Fig. 36 shows the display after selecting schedule with ▷ or Enter ○. The following settings are possible:

- 1 - the day on which automatic tests are to be executed. The settings are: off (no automatic tests), daily, bidaily up to once every/every other/every three/every four weeks. With the weekly intervals you can choose the weekday, examples: Mo 7d = every week on Mondays; Su 21d = every three weeks on Sundays)
- 2 - time when the tests are supposed to start (hours from 00 to 23)
- 3 - time when the tests are supposed to start (minutes from 00 to 59)

The softkey done/F3 finishes the input and takes you back to the function test display (see chapter 10.2).

```

----function test----
interval: Mo - 7d -1
start (hour): 06 -2
start (min): 30 -3
help done
    
```

Fig. 36: Setting schedule

10.2.2 Setting the current monitor window

function test → △▽ current monitor → Enter ○

Selecting current monitor with △ and ▽ followed by ▷ or Enter ○ takes you to the display shown in Fig. 37. Here you can find:

- 1 - the total current,
- 2 - the current window which can be set from 5%, over 10% and 20% up to 50%.
- 3 - the command "measure reference". After selecting this line with △ or ▽ and pressing ▷ or Enter ○ the reference value is set back and measured in the next test again.

The softkey done/F3 finishes the input and takes you back to the display function test (see chapter 10.2). The confirmation prompt save changes? appears again (see Fig. 30). If confirmed with yes/F1, the new values are saved.

```

----function test----
total current 0.0 A -1
current window: 20% -2
measure reference > -3
help done
    
```

Fig. 37: Setting current monitor window

Note: This function should only be programmed for systems with an additional contactor switchover. When using DCM / ACM circuit modules, the selective current monitoring must be programmed individually for each circuit.

10.2.3 Activating/deactivating the preheating phase and finishing the programming

function test → △ ▽ preheat

After selecting this line you can activate or deactivate the preheating phase prior to a test using ◀ and ▶. Afterwards you finish the test programming with the softkey `done`/F3. The confirmation prompt `save changes?` appears again (see Fig. 30). If confirmed with `yes`/F1, the new settings are saved.

10.3 Execution of a capacity test

State → menu/F3 → configuration → Enter ○ △ ▽ → capacity test time → Enter ○

In the state display press `menu`/F3 and navigate with △ and ▽ to `configuration`, press ▶ or Enter ○, and navigate with △ and ▽ to `capacity test time`. Then press ▶ or Enter ○ again. Now you are in the `capacity test` (shown in Fig. 38). Here you can:

- 1 - programm 4 different capacity tests,
- 2 - set the duration time,
- 3 - configure the time (hours, minutes) when the capacity test will start,
- 4 - configure the date (day, month) when the capacity test will start.

You finish the test programming with the softkey `done`/F3. Then the confirmation prompt `save changes?` appears. If you confirm with `yes`/F1, the new settings are saved.

```
----capacity test----
test 1 of 4:          -1
duration:            1h -2
time (hour):         00 -3
time (min):          00
day:                 01 -4
month:               01
help                 done
```

Fig. 38: Test programming

10.4 Test results

State → menu/F3 → △ ▽ test results → Enter ○

Press menu/F3, navigate with △ and ▽ to test results and press ▷ or Enter ○. Now you are in the test results (shown in Fig. 39). You can now see a survey of the saved results of function or capacity tests:

- 1 - last test: the test carried out last on the system
- 2 - function tests: automatically executed function tests
- 3 - capacity tests: automatically executed capacity tests
- 4 - manual tests: manually initiated tests
- 5 - print test log: print of all test results

By pressing ▷ or Enter ○ after selecting a category with △ and ▽ you can see information on the selected test (Beispiel in Fig. 40). The display shows the type of test (Fig. 40, Number 1), execution date and time (Fig. 40, Number 2), the number of tested lamps (Fig. 40, Number 3) as well as the battery characteristics (Fig. 40, Number 4). If there are results of several tests, you can browse them with △ and ▽. When circuit monitoring is activated, these circuits are displayed as well.

By pressing details/F2 you can see further details on the test; back/F3 takes you back to the previous display or the menu item test results.

The menu item print test log (Fig. 39, Number 5) lets you print the saved data of the test log or store in files. You can do this either via internal 19-inch printer (if available) or via Centronics-interface and thus an external printer.

```
----test results-----
last test                -1
function tests          > -2
capacity tests          > -3
manual tests            > -4
print test log          > -5
help                    menu
```

Fig. 39: Survey test results

```
----function test---- -1
--01.01.17 14:06:36-- -2
                        errors   ok
lamps:                 13       42 -3
bat: 226.9V -         5.3A -4
help details          back
```

Fig. 40: Info function test

10.5 Reset errors

State → menu/F3 → △ ▽ reset errors → Enter ○

Press menu/F3, navigate with △ and ▽ to reset errors and press ▷ or Enter ○. You can now see the display shown in Fig. 41.

- 1 - show errors >: Selecting this line with ▷ or Enter ○ takes you to a list of current error messages, from where you can get back by pressing back/F3.
- 2 - You can answer the question “clear error messages?” using the soft-keys yes/F2 or no/F3. Pressing yes/F2 clears ALL error messages. Both keys take you back to the main menu.

```
----reset errors-----
show errors             > -1
                        clear
                        error messages ? -2
help                   yes   no
```

Fig. 41: Reset errors

10.6 Checking the state of the charger

State → INFO-pushbutton LDM

Press the INFO-pushbutton in order to check the state of a charging module. Now the following parameters of the LDM are shown (see Fig. 42): number of the LDM (1), rack and slot number (2), float charge and boost charge or possible failures (3), current (4), voltage (5) and temperature (6). Use the arrow keys ◀ and ▶ to change between information on different charger modules integrated in your system. Possible error messages (shown like Fig. 42, Number 3) are listed in the following table:

```

----- LDM -----
charging unit      1  -1
(rack 8, slot 7)  -2
Float charge      -3
I: (  0.0)0.0 A   -4
U: ( 319.7) 244.8 V -5
T:                34.0 C -6
help              back
    
```

Fig. 42: State of the charger

State	Explanation	Measures
output fuse blown	overcurrent/short circuit	Check Fsec. on LDM or fuses of the respective isolating transformers.
overtemperature	overload or defect	Check secondary fuses. Contact your dealer or the service.
BSW tripped	BSW-output voltage higher than/the SAME as 260V for more than 20sec.	Check secondary fuses. Contact your dealer or the service.
charging off (T_BAT)	battery cabinet temperature >40°C	adjust battery cabinet temperature

Note: In case of a charger failure an error message is shown in the state display (see chapter 9.2).

Note: An indicated charger failure although all LEDs on the respective charger are green (red LEDs off) as well as an LDM not reacting to the INFO-pushbutton are signs for a communication fault.

10.7 System information & system log

State → menu/F3 → △ ▽ diagnosis → Enter ○ → △ ▽ system information → Enter ○

This screen shows the serial number (S/N), firmware and hardware version of the central unit as well as the MAC-address (Fig. 43). Furthermore you can select (△ and ▽) other pages with key parameters and the log (access with ▶ or Enter ○).

```

--system information-
key parameters    >
show log         >
S/N:             0
firmware:        1.8.2 1109
hardware:         21
MAC:00:1f:3e:00:1f:a1
back
    
```

Fig. 43: System information

The key parameters page (Fig. 44) shows the number of installed circuits, the nominal capacity of the battery, the set supply time, the set cut-off voltage, the number of connected charger modules, and the programmed duration of the capacity test.

```

----key parameters---
circuit:          13
battery:          017Ah
supply time:      001h
cut off voltage: 185V
charger:          001
capacity test:    off
help              done
    
```

Fig. 44: System key parameters

In the log (Fig. 45) you can select (△ and ▽) a year; pushing ▶ or Enter ○ takes you to the entries made in the selected year. The table on the next page shows an overview of the possible messages the system log may contain.

```

-----system log-----
2017              >
2016              >
2015              >
2014              >
2013              >
2012              >
back
    
```

Fig. 45: System log

Table 1: System Log Messages

Message	Description
ACM fault <slot>	ACM failure in slot <slot>
act fail	Activation of system failed
act ok	Activation of system was successful
activation	Activation of system required
BAS BB	System operation mode changed to „ready to operate“
BAS LB	System operation mode changed to „charging mode“
BAS MB	System operation mode changed to „modified / ready to operate“
bat. center volt. (<value >)	Invalid symmetry voltage (voltage value)
bat. current (<value >)	Invalid battery current (current value)
bat. discharge (<value >)	Invalid battery discharge (current value)
bat. fuse	Battery fuse blown
bat. temp. < value >	Invalid battery temperature (below +10°C or above 50°C)
bat. temp. sensor	External battery temperature sensor does not respond
bat. voltage (<value >)	Invalid battery voltage (voltage value)
bus scan	Modules were detected
cc	Critical circuit was opened
cc ok	Critical circuit was closed again
cir init	Circuits were initialized
circuit current fault	Current monitoring detected an invalid current
circuit fault	Circuit error detected
ctest	A capacity test was initiated
DCM fault <slot>	DCM failure in slot <slot>
deep discharge 1	Deep discharge, level 1
deep discharge 2	Deep discharge, level 2
defrag	File system was defragmented
earth (<value>;<flag>)	Earth fault in circuit module detected (internal measurement values)
earth-b (<value >;<flag>)	Earth fault in NLSR detected (internal measurement values)
e-mail	Email was sent
e-mail fault	An error occurred when sending an email
format fs	File system was formatted
ftest	A function test was initiated
glt <revision>	BMS gateway detected (revision)
glt gateway	BMS gateway fault
IOM fault <nr>	IOM fault in module #<nr>
L1/L2/L3/N fault	Faulty mains connection, detected non-zero voltage on N-line
lamps <circuit>/<luminaire>	Luminaire fault summary
LDM fault <slot>	Charger failure in slot #<slot>
LDM jumper fault	LDM jumper setting for charging current does not match the detected configuration
LDM revisions	Incompatible versions detected between multiple charging modules. The version must be either smaller than SW 35 or bigger or equal SW 35 in all modules at the same time.
login master	Master-login was carried out
login service	Service-login was carried out
luminaire fault	Luminaire fault detected
mains <L1>V <L2>V <L3>V <N>V <duration>m	Mains failure and return, with voltage values and duration of the power failure
mains fault	Mains failure (configured as error)
mains mb '<sam input>'	System entered into modified non-maintained mode (SAM input)
mains mb ok	System ended the modified non-maintained mode
mains ok	Mains return
maintenance	Maintenance successful
mb fault	System entered into modified non-maintained mode (configured as error)
new firmware	A firmware update was carried out
no TCP/IP sockets	No more TCP/IP sockets available. The WebInterface cannot be accessed.
overload fault <n>	Circuits module is operated with at current above the maximum allowed limit. (Range determined by fuse size)
PCM fault <slot>	PCM failure in slot <slot>
PnP err. <slot>	Plug&Play error in slot <slot> (can occur while configuring the circuit modules or reading from the charging modules)
reset errors	Errors were acknowledged
RS485 fault	RS485 BUS error (SAM, MC-LM)
RSM fault <slot>	RSM error in slot <slot>

RTC error <n>	Real-time clock error (error code)
SAM fault <nr>	SAM error in module #<nr>
subsystem <nr> fault	Substation failure #<nr>
subsystem <nr> mains	Mains failure #<nr> in substation
subsystem <nr> mb	Substation #<nr> entered modified non-maintained mode
system rebooting	System was re-bootet (warm start)
system started <SW version> <HW version> <serial no.>	System was switched on (cold start or warm start)
TCB <cmin> <cmax> <bmin> <bmax>	Measured temperatures: Daily minimum and maximum temperature for cabinet (<cmin> <cmax>) and battery (<bmin> <bmax>)
test <a> cf: ok:<c> lf:<d> ok:<e>	Test result summary with errors a: earth-fault detected b: count of defect circuits c: count of circuits with test result "OK" d: count of defect luminaires e: count of luminaires with test result "OK"
test aborted	Function-/capacity test has been aborted (mains failure while test, aborted by user)
test locked	Function and capacity tests are blocked because the preconditions are not met.
total current fault <wert>	Total current monitoring
uv-c fault <nr>	Sub-distribution fault
uv-c mains <nr>	Mains failrue in sub-distribution

11 De-energising the power supply

Before conducting maintenance works or making changes to the system, it has to be de-energised by a specialist. For this the following instructions have to be observed:

- 1. Operation mode switch to charging mode.** Turn the operation mode switch (Fig. 1, Number 1) to charging mode (position "0").
- 2. Disconnect mains fuses.** Disconnect the mains fuses by opening F1 (Fig. 2, Number 5).
- 3. Disconnect battery fuses.** Disconnect the battery fuses by opening F2 (Fig. 2, Number 11). The system is now shut down.

12 The central control and monitoring unit

The central control and monitoring unit (Fig. 46) is the main control element of this emergency lighting system. It is used to monitor, program and control charging and switching processes. The system status is shown in the backlit LC-display as well as by five multicoloured LEDs. The central control and monitoring unit has the following front interfaces:

- MMC/SD – Slot for importing Firmware-updates
- Ethernet for service tasks
- Parallel interface (Centronics) for the connection of a printer with HP-emulation PCL5/6
- PS/2-interface for an external keyboard (included in delivery)

The system can be operated via key pad with four arrow keys and one enter key as well as three function keys (F1, F2, F3). The system can also be operated via external keyboard using the SAME keys (arrows, F1, F2, F3, and enter). The system firmware can be updated via front MMC slot.

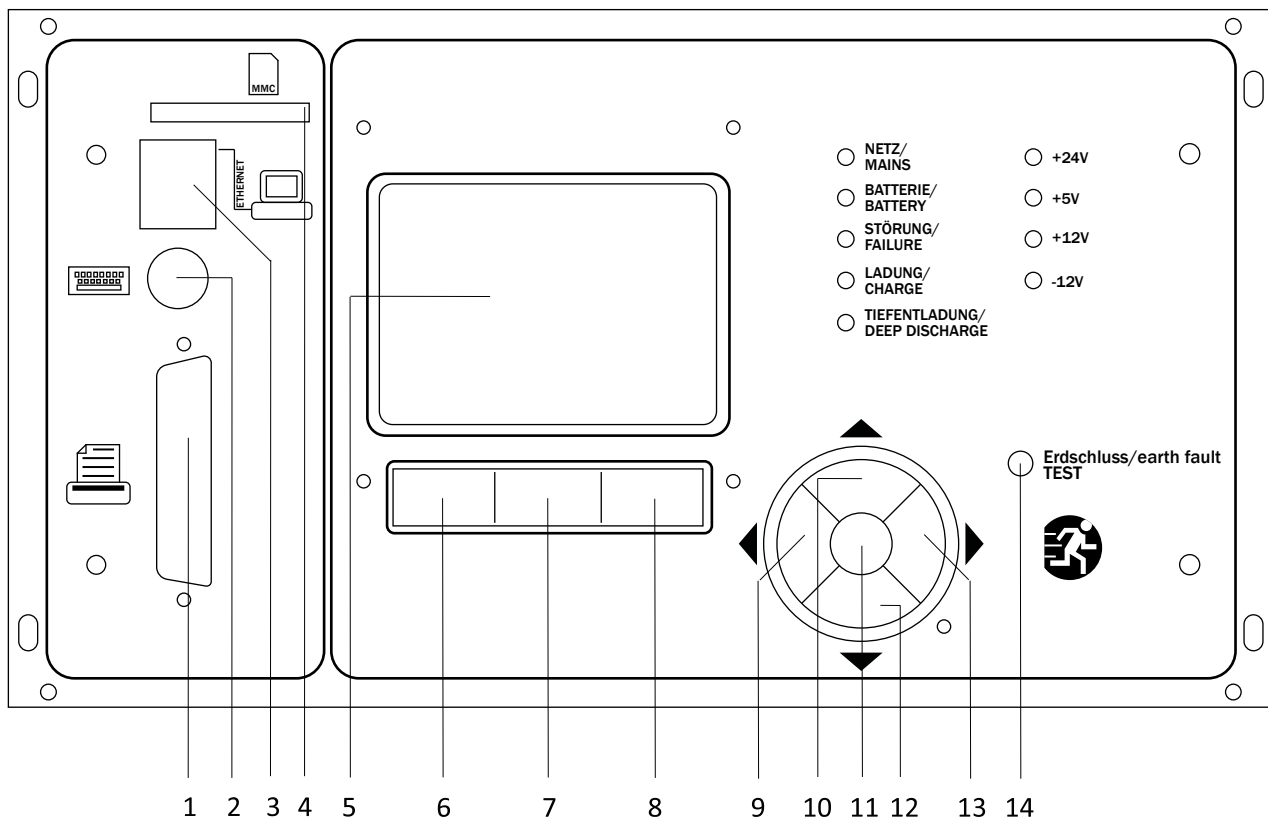

- | | |
|------------------------|-----------------------------------|
| 1 Centronics interface | 8 Function key F3 |
| 2 PS2 interface | 9 Arrow key left |
| 3 Ethernet interface | 10 Arrow key up |
| 4 MMC-Slot | 11 Enter key |
| 5 LC-display | 12 Arrow key down |
| 6 Function key F1 | 13 Arrow key right |
| 7 Function key F2 | 14 Earth fault key ^[4] |

^[4]Simulation of an earth fault, no earth fault detection on the circuits!

Fig. 46: Central control and monitoring unit

12.1 Menu – quick reference guide

Main Menu		
Diagnosis		
Battery		Show battery state and conduct capacity test
Mains		Check mains voltages
Modules		
Circuit modules		Show states of DCM – modules and conduct test
Charger modules		Show states of charger modules (LDM)
SAM/IOM inputs		Check states of SAM- and IOM- inputs
Sub-distribution		Check states of sub-distributions
Subsystems		Check states of subsystems
System information		
Key parameters		Serial number, MAC, show firmware and hardware version
Show log	F4	Number of circuits, battery capacity, supply time etc.
		Show internal system log
Test results		
		View last test
Last test		Show results of the last function or capacity test
Function test		Show function test results
Capacity test		Show capacity test results
Manual test		Show results of a manual test
Print log		Print test results over a certain period of time
Installation		
Modules		Setup modules (operation mode, follow-up time, monitoring...)
Calibrate c-monitor		Calibrate current of the circuit modules
Lamps		Check number of luminaires
Service		Service menu
Detect modules		Detect modules in the system
Operation mode		Define BAS - controlled, ready-to-operate, charging mode
Configuration		
Administration		
Network		
IP - addresses	F6	Set addresses for the network adapter (front + internal)
Communication		Configure status query (system communication)
LCD - Contrast		Set contrast of LC-display
Timer		Configure all timers (switch times, electric circuits)
IOM - inputs		Configure IOM - inputs
SAM - inputs		Configure SAM - inputs
Language selection		Change display language (German, English, French...)
Password		Change authorisation level
Date / Time		Set system time
Function test		
		Turn on/off pre-heating during function test
Schedule		Set time schedule for function test
Current monitor		Set parameters for circuit monitoring
Capacity test time		Set duration, time and date for capacity test
Reset errors		
		Reset error messages
Show errors		Show all error messages
Service address		
		Show contact address for maintenance service

Note: With a connected external PS2-keyboard (included in delivery) you can directly access the following menu items by pressing the function keys F4 and F6

- **Diagnosis** > **System information** > **Show log** (F4) and
- **Configuration** > **Administration** > **Network** > **IP-addresses** (F6).

13 Operation, maintenance and servicing of the batteries

The batteries used in this system are so-called maintenance-free, valve-regulated lead acid batteries. These are lead acid batteries with sealed cells, where no water re-filling is necessary over the whole service life (and which is thus prohibited). The cells are equipped with relief valves to protect them against overpressure. Diluted sulphuric acid absorbed in a glass mat is used as electrolyte.

Note: Opening the valves leads to their destruction and thus to the destruction of the battery.

13.1 Charging and discharging

The system uses an IUTQ-controlled charger unit with a maximum output current of each 2.5A for charging. Several LDM25 connected in parallel in the output ensure a charging current adapted for larger batteries. Batteries, which are later built in a battery assembly as replacement, do not need an equalisation charge with normal float charge voltage in order to adjust to the terminal voltage of other batteries.

The cut-off voltage of the battery, assigned to the discharge current, must not be underrun. For this purpose the power supply system is equipped with a deep discharge protection. The connected load must not exceed the nominal power of the system. Normal mains operation has to be restored as soon as possible after a discharge, also partial discharge, which leads to a re-charging of the batteries. A faulty charger unit has to be repaired.

13.2 Recommended working temperature

The recommended working temperature range for lead acid batteries is 10°C to 30°C. The ideal working temperature range is 20°C ± 5K. Higher temperatures shorten the service life. The technical data apply to the nominal temperature of 20°C. Lower temperatures reduce the available capacity. Do not exceed the limit temperature of 50°C. Avoid permanent working temperatures higher than 40°C (see chapter 10.6).

Temperature (°C)	Charging voltage boost charge (V/Cell)	Float charge voltage (V/Cell)
10	2,48	2,30
20	2,45	2,28
30	2,40	2,24

Note: The charging and maintenance voltages stated apply exclusively to batteries of type OGiV.

13.3 Servicing and inspections

Always keep the batteries clean and dry in order to avoid creeping currents. Cleaning the batteries should be carried out according to the ZVEI-leaflet "Cleaning of batteries". All plastic parts of the batteries must only be cleaned using water without cleansing additive. Do not use organic cleansers. At least every six months the following parameters should be measured and recorded:

- battery voltage
- voltage of some cells/block battery
- surface temperature of some cells/block battery
- battery cabinet temperature

If the cell voltage deviates from the average float charge voltage by ± 0.1 V/cell or if the surface temperature of several cells/blocks deviates by more than 5°C , call a service technician immediately. The following parameters should be measured and recorded annually:

- voltage of all cells/block batteries
- surface temperature of all cells
- battery cabinet temperature
- insulation resistance according to DIN 43539 T I (version relevant on delivery)

Once a year you should also check (visual inspection):

- check naked screw joints (earthing, mains supply, battery cables) for tightness (see required screw joints in chapter 7.2.3)
- the battery rack and room
- ventilation

Check the batteries in compliance with DIN 43539 part I and 100 (draft); furthermore obey the special checking instructions e.g. DIN VDE 0107 and DIN VDE 0108 or also EN 50272-2 (most recent applicable versions). In order to guarantee a reliable power supply, change the entire battery set after the expected service life considering the operational conditions and temperatures.

13.4 First inspection

The first inspection has to be carried out according to E DIN EN 50171 (VDE 0558-508):2013-07 by the installation technician when commissioning the system.

First inspections have to be carried out in compliance with the local, national regulations and comprise the following points:

- check the correct selection of modules. Observe the selectivity of the distribution network of the emergency power supply
- check the correct selection and setting of the automatic transfer and switching device (ATSD)
- visual check of the settings of the protection devices
- check the batteries for sufficient capacity. The system has to be operated with the actual load over the defined time when discharging the batteries. The results have to be logged. When systems do not pass these tests, they have to be tested again. If the system fails again, it must not be commissioned. (see measurement protocol battery)
- check the function by disconnecting from mains
- check the ventilation of the mounting room and the battery according to EN 50272-2
- check the mounting rooms in terms of fire protection, equipment and facilities.

Inspections must only be carried out by electrically skilled technicians, who are trained and qualified.

13.5 Repeating inspection

The repeating inspection has to be carried out in compliance with the local/national regulations. If there are no local/national regulations, the following intervals are recommended:

automatic transfer and switching device (ATSD):

- function test with load transfer: **weekly**
An automatic function test must be programmed by the installation technician/operator upon installation/commissioning (instruction manual chapter 10.2)
- test through imitation of a mains failure: **half-yearly**
disconnection from mains supply through disconnecting the pre-fuse of the system or pushing the mains switch (chapter 7.1.1 (Fig. 5)). The switch has to be switched on again after the function test.

protection devices:

- visual inspection of the settings: **yearly**
 1. check the battery voltage as well as the symmetry voltage (chapter 7.2.3) with a measuring device (see chapter 5)
 2. check the battery current (status screen or chapter 9.2, Fig. 22) by imitating a mains failure (see "testing through imitation of a mains failure") with a measuring device (see chapter 5) or a suitable and calibrated clamp-on ammeter

batteries:

- function test over a sufficient time period with the full consumer load: **monthly**
This is done through weekly function tests.
- capacity test over the rated operating time with the full consumer load: **yearly**
see maintenance schedule

earth fault monitor: **weekly**

- push the earth fault test button, see chapter 12, Fig. 46, Number 14

protection against electric shock

- measured at mains input: every 3 years
- in output circuits with residual current-operated protective device (RCD) through function test, proof of triggering with rated residual operating current: **half-yearly**
Only with installed service socket (SSD)

Beyond the requirements of EN 50272-2, paragraph 14^[5], the battery has to be charged according to the manufacturer's instructions and then, after 24h trickle charging, undergo a discharge test. During the discharging process the central emergency power supply system has to be operated with the full consumer load and it must reach the rated operating time.

^[5] Batteries and their operating conditions must be checked regularly for correct functioning and safety. In compliance with the manufacturer's requirements, the following has to be checked in an inspection: voltage setting of the charger, voltages of the cells or the block batteries, electrolyte density and electrolyte level (if applicable), cleanliness, leak tightness, tightness of the connectors (if necessary), ventilation, plugs and valves, battery temperature.

13.6 Inspection before commissioning

After mounting the central power supply system, the installation technician must carry out the inspections according to HD 60364-6 chapter 61.

Part of them is the visual inspection of the stationary electrical system before the central emergency power supply system is commissioned as well as testing and measuring, preferably in this order:

- conductivity of the cables
- insulation resistance of the electrical system
- protection through SELV, PELV or protective separation
- protection through automatic switch-off of the power supply
- additional protection
- voltage polarity
- phase sequence of the external conductors
- function and operation test
- voltage drop

If an error is detected during the testing and measuring, this and each previous test, which might have been influenced by this error, have to be repeated after clearing the error.

If the installation technician of the central emergency power supply system is not the installation technician of the stationary electrical system, he must be provided with the test log of the first inspection of the stationary electrical system, which the emergency power supply system is meant for, before he can carry out the first inspection of the emergency power supply system.

The observance of the requirements as defined in the instruction manual of the manufacturer has to be proven and confirmed prior to testing and measuring by visual inspection. Particularly the following has to be inspected:

- the condition of the mounting location, marking and equipment according to standards (operating devices, means of body protection, tools, utilities)
- protection against intrusion of solid foreign objects and liquids
- protection against external mechanical impact
- observance of the surrounding temperature (lower and upper limit)
- observance of the maximal humidity
- ensuring the necessary ventilation
- EMV-environment (A or B)
- checking if special operating conditions can disturb the operational safety and functionality of the central emergency power supply system such as vibrations, extraordinary shocks, corrosive atmosphere, strong electric or magnetic fields, explosion hazard
- the existence of necessary operation and maintenance areas for the central emergency power supply system
- the correct selection of modules of the emergency power supply system and check if the requirements of the user according to 5.2 have been met by the manufacturer
- checking the settings of the protection devices

If a system fails an inspection according to E DIN EN 50171 (VDE 0558-508):2013-07 paragraph 8.2.4 sub-paragraph g ^[6], it **must not** be commissioned!

^[6] checking the battery concerning sufficient capacity, the emergency power supply system must be operated during the battery discharge with the rated output current over the rated operating time. Systems, which do fail this test, have to be tested again. If the requirements are not met in this test either, the system must not be commissioned.

13.7 Procedure in case of failure

If you notice malfunctions of the battery set or the charger unit, call the customer service immediately. A service contract with your dealer enables an early recognition of failures.

13.8 Decommissioning, storing and transport

If batteries are stored for a longer time or decommissioned, store them fully charged in a dry frost-free room.

Storage time in relation to the production date	Charging voltage/cell at 20°C	Charging time
shorter than 9 month	2,28V/cell	longer than 72 hours
up to one year	2,35V/cell	48 to 144 hours
1 to 2 Jahre	2,35V/cell	72 to 144 hours

Transport note: Batteries, which show no defects whatsoever, are not treated as dangerous goods according to Dangerous Goods Ordinance Road (GGVS) or Dangerous Goods Ordinance Railway (GGVE), if they are secured against short circuit, slipping, falling over and damage (GGVS, volume no. 2801 a). The batteries to be transported must not show signs of acid on the outside. The respective exception regulations apply to all sealed batteries and cells whose tanks are untight or damaged.

Note: The charging voltage stated apply exclusively to batteries of type OGiV.

14 General information on your system

System type: multiControl plus	
Mounted by:	Date:
Commissioned by:	Date:
Safety signs fixed by:	Date:

14.1 Used battery type

Battery manufacturer: RP-Technik GmbH		Battery type:	
Nominal voltage U_N : 216V	Number of cells (2V):	Number of blocks (6V): ---	Number of blocks (12V): 18
Nominal capacity C_{20} :	20-hour discharge		
Nominal temperature T_N :	20°C		
Ventilation requirements:	according to EN 50 272-2, paragraph 8		
Nominal discharge current: $I_N = I_{20}$	$C_N / 20h$		

15 Technical data

mains supply	1-phase: 230V AC / 3-phase: 400V AC +/-10%
power supply frequency	50/60 Hz +/- 4%
maximum connection power in VA	
consumer connection power (DC) in W	
consumer connection power (AC) in VA	
battery voltage	216V
battery type	
charging power in A	
conservation charging voltage	
strong charging voltage	
charging characteristic curve	IUTQ
characteristic curve switching	automatic
deep discharge 1	
deep discharge 2	
Automatic test system (ATS)	PERC
working mode	maintained or mode non-maintained connecting in switchmode
power supply monitoring	3 phases again N and critical circuits cc MB for switched and unswitched maintained lightload with voltage supply of UV
initiation	≤ 85% Unenn
function test	depending on the programming (daily, weekly)
capacity test	depending on the programming (yearly)
noise suppression	N at VDE 0875
ambient temperature (with battery inserted)	0-35 °C (10-35 °C)
dimension in mm HxWxD	;
potection class	
wire come in	
number of circuits / DCM's	0 /
number of SAM-modules	
number of switch inputs	
number of outputs subdistributors	
number of substations	
fuse mains F1 (L1, L2, L3)	
fuse battery	
fuse connection BMT24 F5, F6	fuse ceramics 5x20mm 0,5AT
fuses for quiescent current loop F7/F8 (not with CCiF)	fuse ceramics 5x20mm 125mAF
fuse BSUE F12/F13	fuse ceramics 5x20mm 1AT
fuse inverse-polarity protection F10/F11	fuse ceramics 5x20mm 1AT
fuse input IOM F30	fuse ceramics 5x20mm 0,5AT
circuit modules DCM12E L(+) and N(-)	fuse ceramics 6,3x32mm 5AT
circuit modules DCM32 L(+) and N(-)	fuse ceramics 6,3x32mm 5AT
circuit modules DCM42 L(+) and N(-)	fuse ceramics 6,3x32mm 6,3AT
circuit modules DCM62 L(+) and N(-)	fuse ceramics 5x20mm 10AFF
modules ACM L(+)	fuse ceramics 5x20mm 4AT
charging module LDM25	fuse ceramics 5x20mm 3,15AT
transformer Fprim (F...)	fuse ceramics 5x20mm 6,3AT
transformer Fsec (F...)	fuse ceramics 4AT
Conductor cross-section	
power supply wire	
battery-cable NSGAFÖU +/-	
symmetry	
final circuit	
potential-free messages	
mains-cable MCVU	
battery cable MCVU	
data lines MCVU	
fuse mains MCVU (L1, L2, L3) (in A)	For multiple outgoing see Note at 7.1.5.
fuse battery MCVU (B+, B-) (in A)	

mains-cable MCUS

battery cable MCUS

data lines MCUS

fuse mains MCUS (L1, L2, L3) (in A)

For multiple outgoings see Note at 7.1.4.

fuse battery MCUS (B+, B-) (in A)

supply-cable MCVU-E

data lines MCVU-E

fuses supply-cable MCVU-E (in A)

16 Module descriptions

Several modules which are integrated in your system or optionally available are briefly described in the following paragraphs. These data can also be downloaded from your dealer's homepage.

16.1 Electric circuit module DCM

Characteristics at a glance:

- 216V DC output voltage in battery operation
- 2 electric circuits per module
- 2x3A, 2x4A, 2x6A output current per module
- mixed mode in the circuit
- single luminaire or circuit monitoring in the circuit



Fig. 47: DCM

The electric circuits of this system are slot-in cards (DCM) in the Euro card format (100x160mm). These cards can contain up to two electric circuits at the same time. When the general power supply fails, they realise the automatic transfer-switching so that the emergency power supply is switched to the electric circuit(s) of the emergency lighting or the power supply of the consumers is switched from general to battery supply. The number of electric circuits depends on the number of circuit cards. 12 circuits can be integrated. Each circuit works separately in changeover mode and can be switched separately. The electric circuits can be programmed either for maintained or non-maintained lighting. A combination of both switching modes in one circuit is also possible. Each circuit has an integrated monitoring unit for monitoring earth fault, overload, electric circuits and single luminaires. These circuits have, depending on the module type, a double pole overcurrent protection device (system protection fuses), which are also monitored in operation (fuse type : DCM32/42 6,3x32mm, ceramic tube, fast, 1500A breaking capacity) (fuse type: DCM62 5x20mm, ceramic tube, superfast, 1500A breaking capacity). By pressing the INFO-pushbutton the LC-display of the central control and monitoring unit (Fig. 24) shows the state of the two electric circuits (A/B) of the module. By means of this display in combination with the direction, enter and function keys you can program operation mode, follow-up time, luminaire monitoring and supply time for each electric circuit.

16.2 Electric circuit module DCM12E

Characteristics at a glance:

- 216V DC output voltage in mains backup operation
- 2 circuits per module
- per module 2x1A output current
- mixed mode operation in the end circuit, integrated single light switchability
- single light and circuit control in the end circuit
- Just in case with luminaires on ELS capable stand (MLED, MU05¹, IL (V57.3.4), KM (V38.5.2, V84.5.2))



Fig. 48: DCM12E

The electric circuit module DCM12E is an end circuit component for emergency lighting systems of the types multiControl *plus*, midiControl, miniControl-XL, miniControl and microControl.

The electric circuit module is equipped with two electric circuits each ("circuit A" and "circuit B"), where each circuit is designed for a maximum output current of 1A(250W). Each electric circuit module can realise a single light scanning as well as a self-calibrating circuit control. Furthermore, each circuit has an earth connection monitoring, which signalizes a possible earth fault in the end circuit by means of a red LED (error). However, this monitoring is only active when the BAS (mode selection switch) is set to charge mode (emergency lighting blocked), i.e. the end circuits are not engaged.

The programming of each control mode of the lights in the end circuit is carried out at the central computer separately for each circuit. The configuration of the lighting switching mode and the single light switchability via powerline requires a PC/Laptop.

16.3 Charger module LDM

Characteristics at a glance:

- charger unit complies with TVE TNORM E 8002, EN 50172, EN 50171 (versions relevant on delivery)
- IUTQ – curve family complies with EN 50272-2 (versions relevant on delivery)
- integrated battery voltage monitor (BSW)
- processor-controlled charging curve (no settings necessary)



Fig. 49:LDM

The 19" charger module LDM supplies a charging current of up to 2.5A. It is connected to the primary voltage of the respective isolating transformer via terminals on the rear bus plate. Additionally, the LDM has an integrated battery voltage monitor which protects the battery from overloading. The processor-controlled charging curve enables the LDM to load the batteries independent from the control computer.

16.4 Input/Output-module

Characteristics at a glance:

- analysis of 7 system states according to EN 50171 (versions relevant on delivery)
- 7 potential-free switch contacts
- 4 galvanically isolated inputs (18-120V DC)
- up to 5 IOM-modules can be integrated in a system
- communication with multiControl *plus* System via controlled internal CAN-bus



Fig. 50: IO-module

The IOM-module has 7 relay outputs 230V/6A with potential-free changeover contacts. IOM-module Nr. 1 is pre-programmed for the connection of a conventional message display and control unit. It is furthermore equipped with 4 galvanically isolated, reverse polarity tolerant switch inputs 18-120V DC. Individual message texts are programmable for each input.

16.5 Switch query module SAM24 (optional)

Characteristics at a glance:

- 8 (7+1) reverse-polarity tolerant control inputs for detecting the general lighting
- integrated mains monitor (active through DIP-switch)
- 2 COM ports for feed-through or star-shaped wiring
- integrated repeater function for COM port2 (COMboost)
- integrated terminating resistor (active through DIP-switch)
- integrated function monitoring of the BUS line
- communication via RS485 Bus



Fig. 51: SAM24-module

The interface module SAM24 allows the direct interfacing of an emergency lighting system with a general lighting installation. It is to monitor the operation status of the general lighting system in order to achieve a joint switching of emergency lights and the general lighting when mains-operated. Normally-closed contacts as well as normally-open contacts of the general lighting can be monitored; it is also possible to directly connect phases of the general lighting in order to activate the emergency lighting in case of a general lighting failure. Up to 16 SAM interface modules can be connected to the emergency lighting system via the BUS line, which provides a sufficient number of inputs.

16.6 multiControl *plus* Line Monitor MC-LM (optional)

characteristics at a glance:

- three-phase mains monitoring
- data transmission via bus system
- safe data protocol: no E30-line necessary
- possible connection of up to 16 MC-LM per system
- display of a programmed message text (where connected to the general lighting)
- integrated terminating resistor
- communication via RS485 bus



Fig. 52: MC-LM

The multiControl *plus* Line Monitor MC-LM mainly monitors the general mains installation (voltage supply of the general lighting). The MC-LMs are bus-compatible mains monitors for the connection to the multi-bus (RS485) of an multiControl *plus* emergency lighting system and they are suitable for switching the integrated maintained and non-maintained light changeover switchings in the system. The MC-LM can monitor three phases of e.g. a mains distribution. 85% of the nominal mains voltage (230V AC), i.e. at ca. 195V AC, is the switch threshold for the recognition of a mains failure or an intense mains voltage fluctuation. The MC-LM can be addressed separately and are connected to the multiControl *plus* system in series (feed through wiring) via screened 4-core data line; up to 16 of these MC-LM can be connected via this line. J-Y(St)-Y or similar in compliance with DIN VDE 0815 and 0816 (versions relevant on delivery) have to be used as data line.

16.7 PC230 (optional)

characteristics at a glance:

- three-phase mains monitoring
- 2 potential-free changeover contacts with a rating of 2A at 230V/AC
- dimensions (L x W x H): 96 x 36 x 54



Fig. 53: PC230

The Power-Control (PC230) monitors voltages in sub-distributions of the general lighting. Three phases can be monitored. If fewer phases are monitored, unused monitoring contacts have to be bridged with connected contacts. The upper switch threshold is limited to 195 V, i.e. 15% lower than mains voltage of 230V. The state of the changeover contacts can be queried from the module. Usually one of these contacts is integrated in a monitoring loop of an emergency lighting system. The NC-contact [18-15] or [28-25] has to be wired. If the contacts are used for other purposes, please strongly observe the power rating of 2A-30V/DC, 0.3A-110V/DC or maximal 0.5A-230 V/AC/50Hz. This module has a plastics housing designed for rail mounting (TS35).

16.8 MCT15(S) / MCT15U(S) (optional)

Characteristics at a glance:

- display of the system status in plain text
- visual (LED) and acoustic indications of the system statuses
- remote triggering of the test function
- BUS-compatible
- possible to switch the system operating mode
- possible to switch maintained light consumers on and off



Fig. 54: MCT15(S)

The remote panels MCT-15 and MCT-15S are designed to provide a decentralised display of the statuses of emergency lighting systems of types MC-series. The panel provides visual and acoustic indications of the respective system status. Visual indications are provided in the form of plain text and LED. In the event of faults, an acoustic signal is also issued. The acoustic signal can be acknowledged with the „RESET acoustic signal“ button although this does not influence the error message (visual indication). In addition to these indications, statuses such as Mod non-maintained, test operation, mains OK, batt. OK, DCM fault etc. are also displayed in plain text. By using the (ON/OFF) button or key switch on the MCT-15, it is possible to switch the system operating mode from charging mode to standby mode or vice versa. By pressing the Switch „DS On/Off“ the maintained circuits of the system can be turned on and off.

However, in the event that no key switch is integrated into the indicator panel it is necessary to ensure that the MCT-15 is safeguarded against access by unauthorised personnel (DIN VDE 0108 part 1 section 6.4.3.11). In order to be able to trigger the external test function, the test button must be pressed until the message „ready“ appears in the display. This is necessary to prevent an accidental triggering of the test function. Please refer to the wiring documentation for connection variants and connection schematics.

17 Connection examples

Anschlussbeispiel SAM24 connection example SAM24

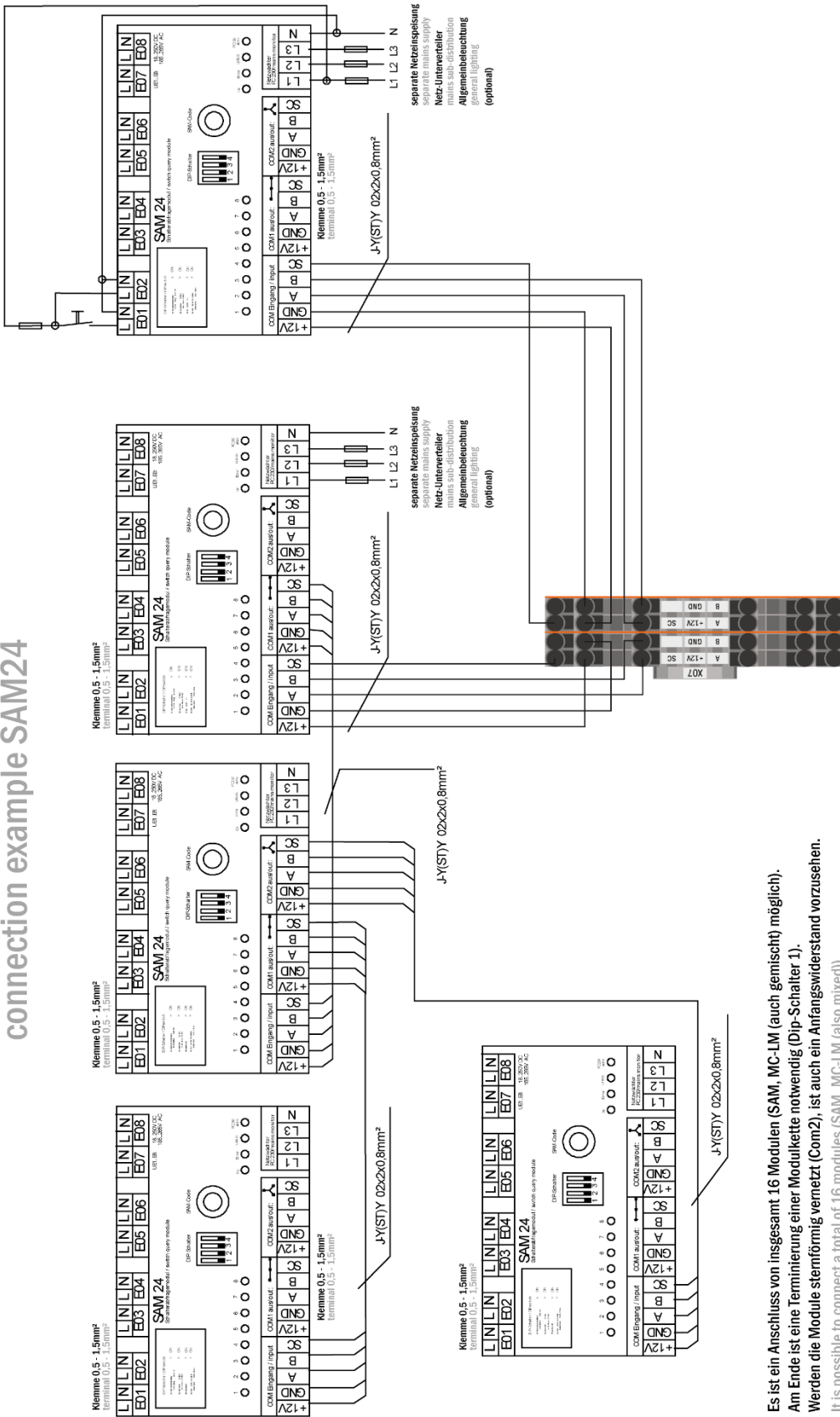

Es ist ein Anschluss von insgesamt 16 Modulen (SAM, MC-LM (auch gemischt) möglich).
 Am Ende ist eine Terminierung einer Modulkette notwendig (Dip-Schalter 1).
 Werden die Module sternförmig vernetzt (Com2), ist auch ein Anfangswiderstand vorzusehen.
 It is possible to connect a total of 16 modules (SAM, MC-LM (also mixed)).
 At the end, a termination of a module chain is necessary (dip switch 1).
 If the modules are networked in a star-shaped manner (Com2), an initial resistance must also be provided.

Anschlussbeispiel PC230 connection example PC230

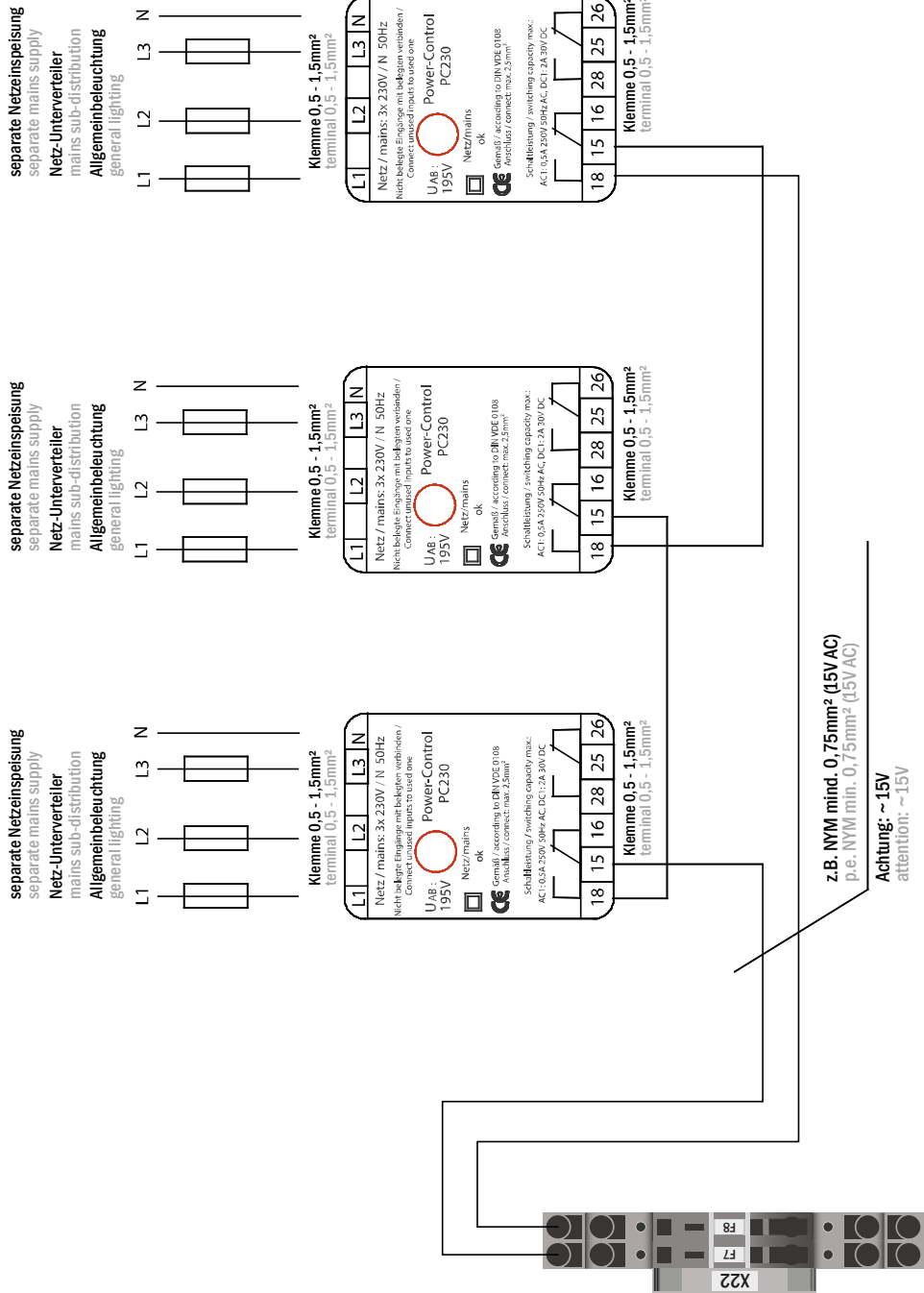

Anschlussbeispiel MC-LM connection example MC-LM

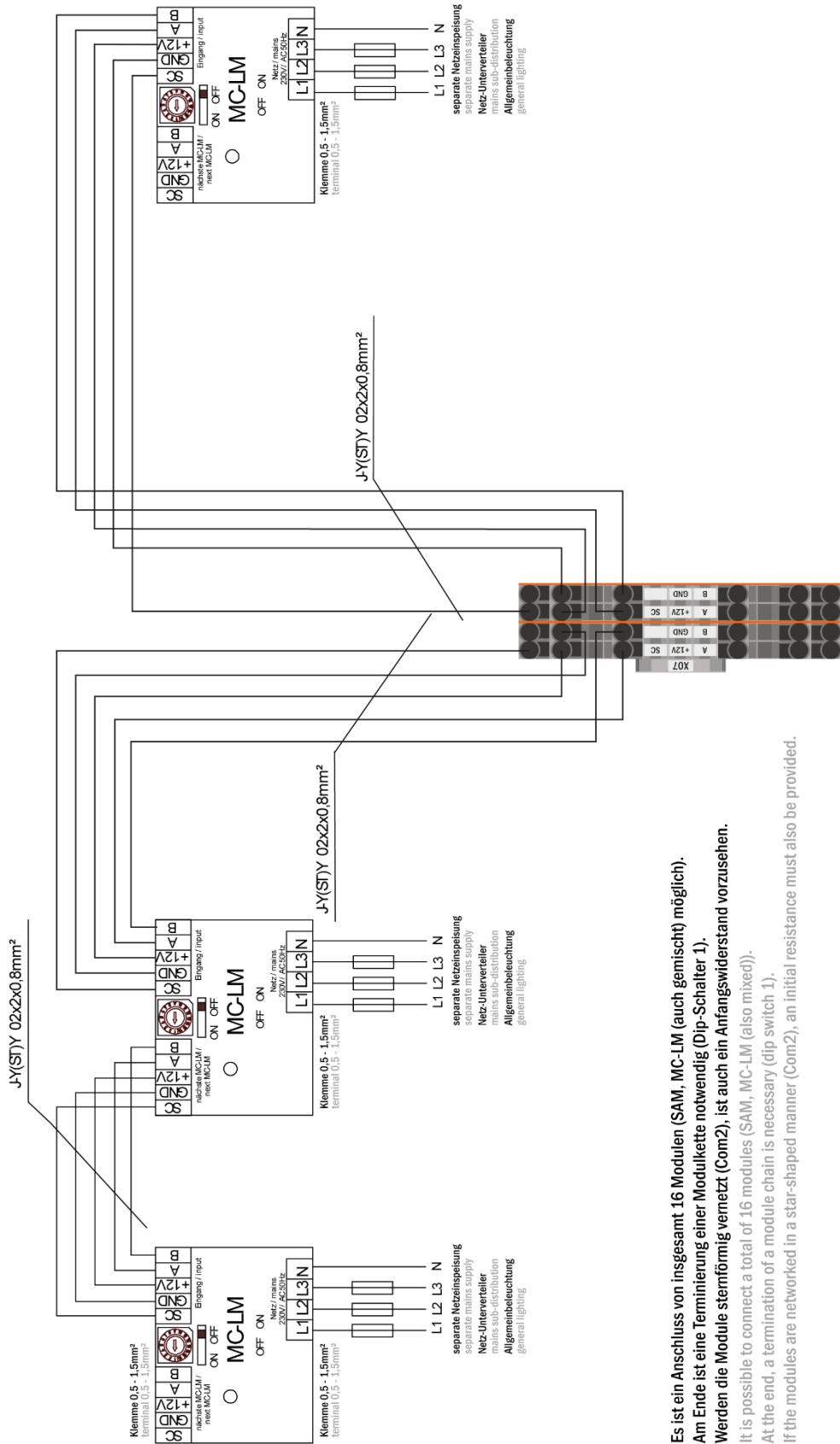

Es ist ein Anschluss von insgesamt 16 Modulen (SAM, MC-LM (auch gemischt) möglich).
Am Ende ist eine Terminierung einer Modulkette notwendig (Dip-Schalter 1).
Werden die Module sternförmig vernetzt (Com2), ist auch ein Anfangswiderstand vorzusehen.
It is possible to connect a total of 16 modules (SAM, MC-LM (also mixed)).
At the end, a termination of a module chain is necessary (dip switch 1).
If the modules are networked in a star-shaped manner (Com2), an initial resistance must also be provided.

Anschlussbeispiel MCT15 connection example MCT15

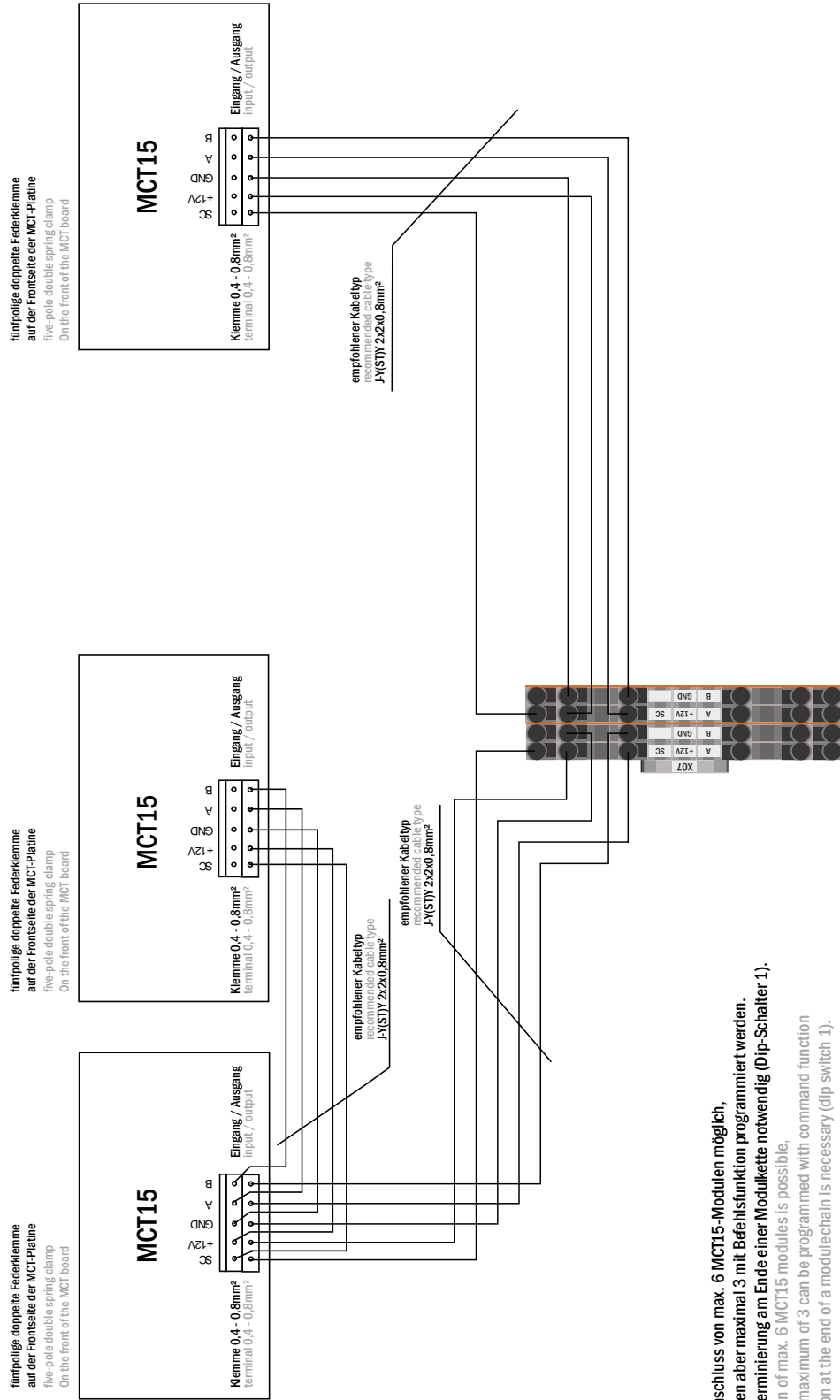

Es ist ein Anschluss von max. 6 MCT15-Modulen möglich, davon können aber maximal 3 mit Befehlsfunktion programmiert werden. Es ist eine Terminierung am Ende einer Modulkette notwendig (Dip-Schalter 1).
A connection of max. 6 MCT15 modules is possible. However, a maximum of 3 can be programmed with command function. A termination at the end of a module chain is necessary (dip switch 1).

18 Revision history

multiControl <i>plus</i> – Setup & Commissioning		
version	date of issue	most important changes compared to previous version
1.0	09.05.2012	-
1.2.2	17.02.2017	added chapter: first inspection, repeating inspection, inspection before commissioning, procedure in case of failure
1.2.3	26.07.2017	added: ACM, fuses sub-distributor and substation
1.2.4	23.11.2017	Changed switching contacts point 7.1.8
1.2.5	30.11.2017	Changed fan control point 7.1.8
1.2.6	13.12.2017	Corrections
1.2.7	07.03.2018	Changed mains input, changed IO-Module galv. Isolated switch input voltage (18-120V DC)
1.2.8	18.04.2018	Added: terminal x18, x19

19 Circuit table

Circuit	Location	P(VA)	Number of luminaires
1			
2			
3			
4			
5			
6			
7			
8			
9			
10			
11			
12			
13			
14			
15			
16			
17			
18			
19			
20			
21			
22			
23			
24			
25			
26			
27			
28			
29			
30			
31			
32			

Central Power Supply System multiControl plus

Setup & Commissioning

33			
34			
35			
36			
37			
38			
39			
40			
41			
42			
43			
44			
45			
46			
47			
48			
49			
50			
51			
52			
53			
54			
55			
56			
57			
58			
59			
60			
61			
62			
63			
64			
65			
66			
67			

68			
69			
70			
71			
72			
73			
74			
75			
76			
77			
78			
79			
80			
81			
82			
83			
84			
85			
86			
87			
88			
89			
90			
91			
92			
93			
94			
95			
96			

20 Measurement protocols battery

Date:				Time:			
Block 01		Block 02		Block 03		Block 04	
Block 05		Block 06		Block 07		Block 08	
Block 09		Block 10		Block 11		Block 12	
Block 13		Block 14		Block 15		Block 16	
Block 17		Block 18		Symmetry		Total	

Date:				Time:			
Block 01		Block 02		Block 03		Block 04	
Block 05		Block 06		Block 07		Block 08	
Block 09		Block 10		Block 11		Block 12	
Block 13		Block 14		Block 15		Block 16	
Block 17		Block 18		Symmetry		Total	

Date:				Time:			
Block 01		Block 02		Block 03		Block 04	
Block 05		Block 06		Block 07		Block 08	
Block 09		Block 10		Block 11		Block 12	
Block 13		Block 14		Block 15		Block 16	
Block 17		Block 18		Symmetry		Total	

Date:				Time:			
Block 01		Block 02		Block 03		Block 04	
Block 05		Block 06		Block 07		Block 08	
Block 09		Block 10		Block 11		Block 12	
Block 13		Block 14		Block 15		Block 16	
Block 17		Block 18		Symmetry		Total	

Date:				Time:			
Block 01		Block 02		Block 03		Block 04	
Block 05		Block 06		Block 07		Block 08	
Block 09		Block 10		Block 11		Block 12	
Block 13		Block 14		Block 15		Block 16	
Block 17		Block 18		Symmetry		Total	

Date:				Time:			
Block 01		Block 02		Block 03		Block 04	
Block 05		Block 06		Block 07		Block 08	
Block 09		Block 10		Block 11		Block 12	
Block 13		Block 14		Block 15		Block 16	
Block 17		Block 18		Symmetry		Total	

