

RPower OGiV12750LP (12V 75Ah AGM Battery)

Floating Life at 20°C designed for up to 12 years

EAN: 4260349823401

Dimensions

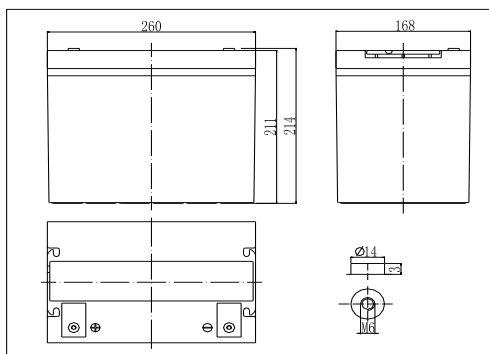

Specifications

Nominal Voltage		12V
Capacity (10hr@25°C@1.80V/C)		75Ah
Dimensions (±2mm)	Length	258mm (10.2inch)
	Width	166mm (6.54inch)
	Height	206mm (8.11inch)
	Total Height	215mm (8.46inch)
Approx. Weight		22.50kg (49.60lbs)
Maximum charging current		22.5A
Maximum discharge current		700A (5sec.)
Internal resistance		Approx. 5.7mΩ
Capacity affected by temperature (20hr)	40°C	103%
	25°C	100%
	0°C	86%
	-15°C	65%
Self-discharge (25°C)	3 month	Remaining Capacity: 91%
	6 month	Remaining Capacity: 82%
	12 month	Remaining Capacity: 65%
Nominal operating temperature		25°C ±3°C (77°F±5°F)
Operating temperature range		-20°C~55°C (-4°F~131°F)
Float charging voltage (25°C)		13.65 to 13.80V
Cyclic charging voltage (25°C)		14.40 to 15.00V
Terminal material		Copper

The Relationship for Charging Voltage and Temperature

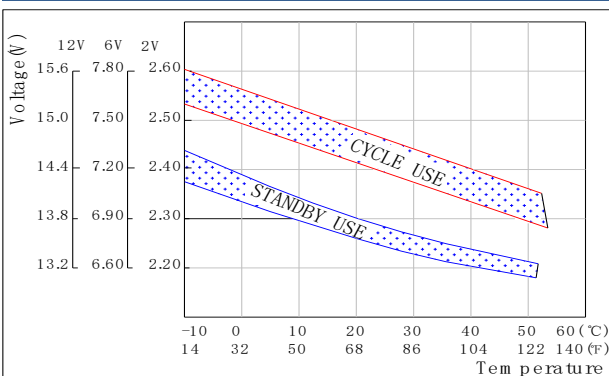

Charging Characteristics (25°C)

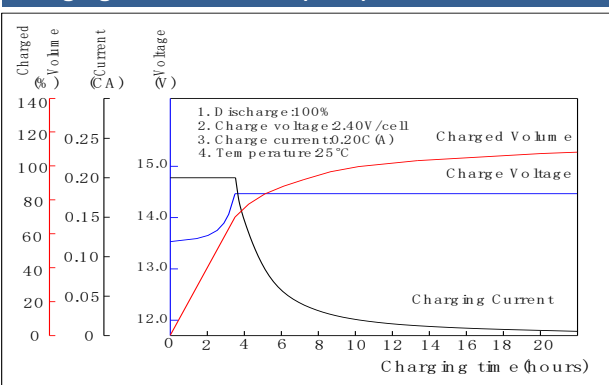

Discharge Characteristics (25°C)

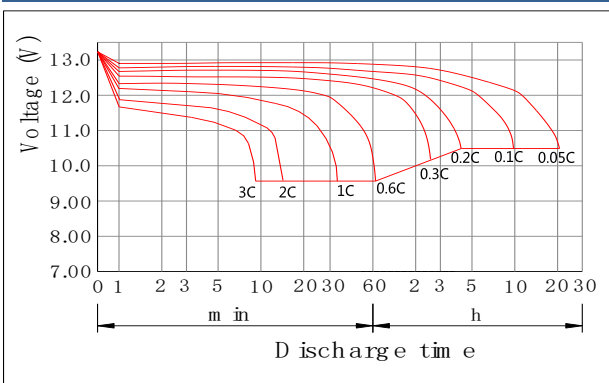

Constant Current Discharge Characteristics (Ampere / Battery, 25°C)

FV / TIME	5min	10min	15min	20min	30min	45min	1h	2h	3h	4h	5h	6h	8h	10h	20h
10.98V	174,60	134,83	108,64	89,82	70,91	51,70	42,10	24,93	19,21	15,23	12,90	11,06	8,68	7,28	3,93
10.80V	180,00	139,00	112,00	92,60	73,10	53,30	43,40	25,70	19,80	15,70	13,30	11,40	8,95	7,50	4,05
10.50V	195,00	151,00	117,00	96,10	73,60	53,70	45,30	26,80	20,60	16,20	13,50	11,50	9,04	7,55	4,08
10.20V	206,00	158,00	122,00	99,40	77,00	55,00	46,90	27,50	21,00	16,60	13,90	11,80	9,18	7,60	4,10
9.90V	222,00	169,00	131,00	104,00	78,30	56,40	47,50	27,90	21,40	16,80	14,10	12,00	9,26	7,65	4,13
9.60V	240,00	178,00	137,00	109,00	81,80	61,70	50,20	28,90	21,80	17,10	14,30	12,10	9,33	7,67	4,14

Constant Power Discharge Characteristics (Watt / Battery, 25°C)

FV / TIME	5min	10min	15min	20min	30min	45min	1h	2h	3h	4h	5h	6h	8h	10h	20h
10.98V	1984,62	1519,02	1233,84	1024,32	820,62	616,92	490,04	288,67	221,16	176,93	126,88	126,88	97,78	80,32	43,36
10.80V	2046,00	1566,00	1272,00	1056,00	846,00	636,00	505,20	297,60	228,00	182,40	130,80	130,80	100,80	82,80	44,70
10.50V	2136,00	1644,00	1338,00	1098,00	852,00	666,00	519,00	301,80	229,80	183,60	132,60	132,60	103,20	85,20	45,06
10.20V	2250,00	1740,00	1422,00	1146,00	870,00	666,00	538,80	309,60	233,40	184,80	132,60	132,60	103,80	86,40	45,24
9.90V	2418,00	1800,00	1446,00	1182,00	918,00	708,00	561,60	316,80	235,20	187,80	159,60	135,60	106,20	88,20	45,60
9.60V	2478,00	1884,00	1476,00	1212,00	948,00	720,00	574,20	324,60	241,20	190,80	160,80	137,40	108,00	90,60	45,72